

## Lumileds

### IESNA LM-80 Test Report

#### 1. Description of LED light sources tested

LUXEON 3030 2D: L130-3080003000W2C (nominal CCT 3000K)

#### 2a. Package Pictures



Figure 1. Picture of LUXEON 3030 2D.

#### 2b. Average current density per LED die at max. current tested

360.0 mA/mm<sup>2</sup>

#### 2c. Average power density per LED die at max. current tested

2.21 W/mm<sup>2</sup>

#### 2d. Average CRI Ra of LED light sources tested at max. current tested

82.99

#### 2e. Minimum die edge to die edge spacing of LED light sources tested

0.1mm

#### 2f. Total Input Power at max. current tested

1.17 W

### 3a. Projected $L_{70}$ extrapolations per IESNA TM-21-11

	If = 65mA	If = 100mA	If = 120mA	If = 150mA	If = 180mA
Ts = 115°C	-	-	142,789	-	110,606
Ts = 105°C	178,097	-	141,655	128,541	-
Ts = 85°C	-	153,225	-	-	-
Ts = 55°C	202,126	-	-	-	-

### 3b. Reported $L_{70}$ extrapolations per IESNA TM-21-11

	If = 65mA	If = 100mA	If = 120mA	If = 150mA	If = 180mA
Ts = 115°C	-	-	> 60,000	-	> 60,000
Ts = 105°C	> 60,000	-	> 60,000	> 60,000	-
Ts = 85°C	-	> 60,000	-	-	-
Ts = 55°C	> 60,000	-	-	-	-

## 4. Applicable LUXEON® Series part number(s)

This IESNA LM-80 Test Report applies to the following LUXEON part numbers:

Product Family	Part Number	CCT
LUXEON 3030 2D	L130-AABBxx30xxxxx	white
LUXEON HR30	L130-AABBCCCHR00000	white

For LUXEON 3030 2D: AA designates nominal CCT (22=2200K, 27=2700K, 30=3000K, 35=3500K, 40=4000K, 50=5000K, 57=5700K and 65=6500K), BB designates minimum CRI (70=70CRI, 80=80CRI and 90=90CRI), CC designates ESD protection level (00=2kV and 0T=8kV), xx and xxxxx designate Lumileds internal codes.

For LUXEON HR30: AA designates nominal CCT (22=2200K, 27=2700K, 30=3000K, 35=3500K, 40=4000K, 50=5000K, 57=5700K, 65=6500K), BB designates minimum CRI (70=70CRI, 80=80CRI and 90=90CRI), and CC designates ESD protection level (00=2kV and 0T=8kV).

## 5. Number of LED light sources tested

25 units per test condition.

## 6. Dates Tests Started

2016/08/24.

## 7. Date Report First Issued

2017/10/17.

## 8. Mechanical Drawing

For detailed mechanical drawings, please see individual product data sheets.

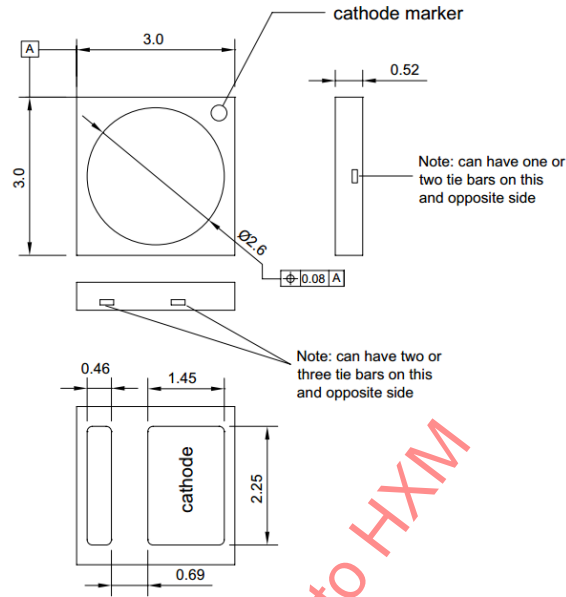

Figure 2: Mechanical Drawing for LUXEON 3030 2D. All dimensions are in millimeters.

## 9. $T_s$ Measurement Point

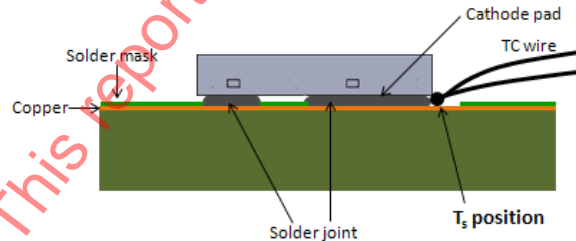

Figure 3: Preferred  $T_s$  measurement point for LUXEON 3030 2D.

For further information on measuring the in-situ  $T_s$ , please see Lumileds Application Brief AB207, which is available online at [www.lumileds.com](http://www.lumileds.com).

## 10. Description of auxiliary equipment

LUXEON LED devices are soldered to reliability stress boards.

Reliability stress boards are mounted in a chamber with minimal ambient airflow. The chamber temperature is controlled based on the temperature of a control  $T_s$  point, which is located on the stress board.

The reliability stress board is periodically removed from the thermal chamber, allowed to cool to room temperature, and then tested. After testing, the reliability stress board is returned to the thermal chamber for additional operation.

## 11. Operating Cycle

LUXEON LEDs are driven with a constant direct current (DC).

## 12. Ambient conditions including airflow, temperature, and relative humidity

The typical relative humidity within the chamber is < 65%. The temperature uniformity of the board (center to edge) was experimentally determined to be less than 2°C.

The photometry measurement temperature is set and monitored to be within 25°C ± 2°C with no forced airflow and RH < 65%.

## 13. $T_s$ and ambient temperatures (ambient temperature measured 5mm above reliability stress board)

In all cases, both  $T_s$  and  $T_{air}$  meet or exceed the IESNA LM-80-08 limits.

## 14. Drive current of the LED light source during lifetime test

See tables.

## 15. Initial luminous flux and forward voltage at photometric measurement current

See tables.

## 16. Lumen maintenance for data for each individual light source along with median value, standard deviation, minimum and maximum lumen maintenance value for all of the light sources

See tables.

## 17. Observation of LED light source failures including the failure conditions and time of failure

No failures observed in devices reported.

## 18. LED light source monitoring interval

Units were tested at 0 hour and at subsequent 1,000 hours intervals.

## 19. Photometric measurement uncertainty

Long-term measurement uncertainty is based on reproducibility tests done over a period of one year, calculated to k = 2 coverage (i.e. 95% coverage).

Luminous Flux ( $\Phi_v$ ) ± 1.59%

Correlated Color Temperature (CCT) ± 21K

## 20. Chromaticity shift reported over the measurement time

See tables.

## 21. Sampling Method/Sample size

Tested samples are selected to be representative of the overall LED population. LED sample size is indicated in Section 5 of this report.

## 22. ISO 17025-2005 Accreditation

**SINGAPORE LABORATORY ACCREDITATION SCHEME**

**SINGAPORE ACCREDITATION COUNCIL**

Number : **LA-2016-0634-E**

Date of Issue : **14 December 2016**

Date of Expiry : **13 December 2020**

# Certificate of Accreditation

This certifies that

**Lumileds Malaysia Sdn. Bhd.**  
**Reliability Test Laboratory**  
**No. 3, Lintang Bayan Lepas 8,**  
**Phase 4, Bayan Lepas Industrial Park**  
**11900, Penang, Malaysia**

is accredited by the Singapore Accreditation Council to

**ISO / IEC 17025 : 2005**

for specific scope within the field of

**Electrical Testing**

as detailed in the attached schedule.

  
Chairman

This Certificate is awarded subject to the organisation's compliance with the stated criteria and terms and conditions laid down by the Singapore Accreditation Council.

This Certificate may not be reproduced except with the written permission of the Chairman.

## Notes

Data is for reference only and is not an endorsement to exceed the Data Sheet operating conditions. The data was collected by a subcontracted laboratory (ref. R2SH160822052-10, R2SH160822053-10 and R2SH160822051-10).

The TM-21 extrapolations are based on IES TM-21-11 "Projecting Long Term Lumen Maintenance of LED Light Sources. The TM-21 lumen maintenance model is based on the flux data normalized to 1 at 0 hours and the use of an exponential model for flux(time):

Flux(time) = B exp[-alpha\*time], where normally B ≅ 1, and alpha > 0.

An L70 extrapolation less than 0 means that the model predicts an increasing flux output with time, i.e. alpha < 0 (see graphs). Generally, this means that additional test time is needed to determine the long-term lumen maintenance behavior.

## Disclaimer

Although LUMILEDS has attempted to provide the most accurate information and materials and services data (hereinafter "Data"), the Data is provided "as is" and may contain errors. The entire risk of use of the data shall be with the user. LUMILEDS makes no warranty, express or implied, including, but not limited to, the implied warranties of merchantability and fitness for a particular purpose, regarding the contents or correctness of the Data provided or the ability of the Data to meet the user's needs or expectations. LUMILEDS reserves the right to make changes without notice. You as user agree to this disclaimer and user agreement with the download or use of the provided materials and Data.

In no event shall LUMILEDS be liable for any direct, indirect, special, incidental, exemplary, or consequential damages arising out of or related to the use of the Data, however caused, regardless of theory of liability, and whether or not LUMILEDS has been advised of the possibility of such damage. This limitation shall apply notwithstanding any failure of essential purpose or any exclusive remedy.

### Normalized Flux Statistics for I<sub>f</sub> = 65mA

	0hrs	1000hrs	2000hrs	3000hrs	4000hrs	5000hrs	6000hrs	7000hrs	8000hrs	9000hrs	10000hrs	alpha	B	L70	
Ts=Tair=105°C	median =	1.0000	1.0018	0.9999	0.9985	0.9970	0.9953	0.9928	0.9910	0.9895	0.9878	0.9855			
	average =	1.0000	1.0017	1.0001	0.9988	0.9972	0.9953	0.9932	0.9913	0.9892	0.9873	0.9852	2.0333e-06	1.0055	178,097
	st dev =	0.0000	0.0008	0.0011	0.0013	0.0015	0.0015	0.0015	0.0017	0.0021	0.0022	0.0024			TM-21 L70(10k) > 60,000hrs
	min =	1.0000	1.0001	0.9983	0.9970	0.9945	0.9925	0.9911	0.9879	0.9846	0.9823	0.9796			
	max =	1.0000	1.0031	1.0023	1.0015	0.9996	0.9989	0.9970	0.9951	0.9932	0.9918	0.9910			
Ts=Tair=55°C	median =	1.0000	1.0037	1.0026	1.0018	1.0003	0.9990	0.9972	0.9960	0.9939	0.9917	0.9900			
	average =	1.0000	1.0035	1.0026	1.0019	1.0004	0.9990	0.9975	0.9958	0.9939	0.9920	0.9901	1.8055e-06	1.0083	202,126
	st dev =	0.0000	0.0010	0.0010	0.0013	0.0009	0.0012	0.0011	0.0012	0.0016	0.0019	0.0022			TM-21 L70(10k) > 60,000hrs
	min =	1.0000	1.0014	1.0004	0.9996	0.9989	0.9973	0.9951	0.9934	0.9907	0.9890	0.9866			
	max =	1.0000	1.0052	1.0045	1.0038	1.0020	1.0015	0.9992	0.9976	0.9969	0.9968	0.9962			

Lumen Maintenance for If = 65mA  
Normalized to 1 at 0 hours

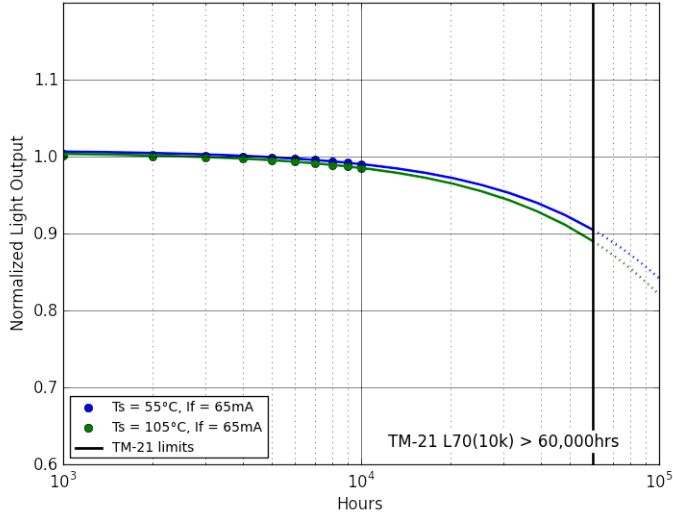

Delta u'v' for If = 65mA

	0hrs	1000hrs	2000hrs	3000hrs	4000hrs	5000hrs	6000hrs	7000hrs	8000hrs	9000hrs	10000hrs	
Ts=Tair=105°C	median =	0.0000	0.0004	0.0007	0.0009	0.0013	0.0014	0.0016	0.0020	0.0023	0.0026	0.0030
	average =	0.0000	0.0004	0.0007	0.0008	0.0013	0.0015	0.0016	0.0019	0.0023	0.0026	0.0029
	st dev =	0.0000	0.0001	0.0001	0.0001	0.0001	0.0001	0.0001	0.0001	0.0001	0.0001	0.0001
	min =	0.0000	0.0002	0.0005	0.0007	0.0011	0.0013	0.0014	0.0017	0.0021	0.0025	0.0027
	max =	0.0000	0.0006	0.0009	0.0010	0.0014	0.0017	0.0018	0.0022	0.0026	0.0029	0.0032
Ts=Tair=55°C	median =	0.0000	0.0003	0.0004	0.0005	0.0010	0.0012	0.0014	0.0018	0.0022	0.0024	0.0026
	average =	0.0000	0.0003	0.0004	0.0005	0.0010	0.0013	0.0015	0.0018	0.0022	0.0024	0.0027
	st dev =	0.0000	0.0002	0.0002	0.0002	0.0002	0.0002	0.0002	0.0002	0.0002	0.0002	0.0002
	min =	0.0000	0.0001	0.0003	0.0003	0.0008	0.0011	0.0012	0.0016	0.0019	0.0022	0.0024
	max =	0.0000	0.0009	0.0010	0.0010	0.0017	0.0019	0.0021	0.0024	0.0027	0.0030	0.0033

This report is UNCLASSIFIED

**Normalized Flux Statistics for  $I_f = 100\text{mA}$**

	0hrs	1000hrs	2000hrs	3000hrs	4000hrs	5000hrs	6000hrs	7000hrs	8000hrs	9000hrs	10000hrs	alpha	B	L70
median =	1.0000	0.9982	0.9963	0.9953	0.9935	0.9917	0.9889	0.9870	0.9851	0.9823	0.9790			
Ts=Tair=85°C average =	1.0000	0.9986	0.9968	0.9952	0.9937	0.9916	0.9893	0.9870	0.9848	0.9825	0.9798	2.3496e-06	1.0034	153,225
st dev =	0.0000	0.0017	0.0019	0.0018	0.0019	0.0020	0.0020	0.0022	0.0026	0.0026	0.0027	TM-21 L70(10k) > 60,000hrs		
min =	1.0000	0.9962	0.9935	0.9925	0.9906	0.9880	0.9859	0.9835	0.9806	0.9784	0.9752			
max =	1.0000	1.0028	1.0018	0.9991	0.9982	0.9963	0.9935	0.9915	0.9896	0.9877	0.9852			

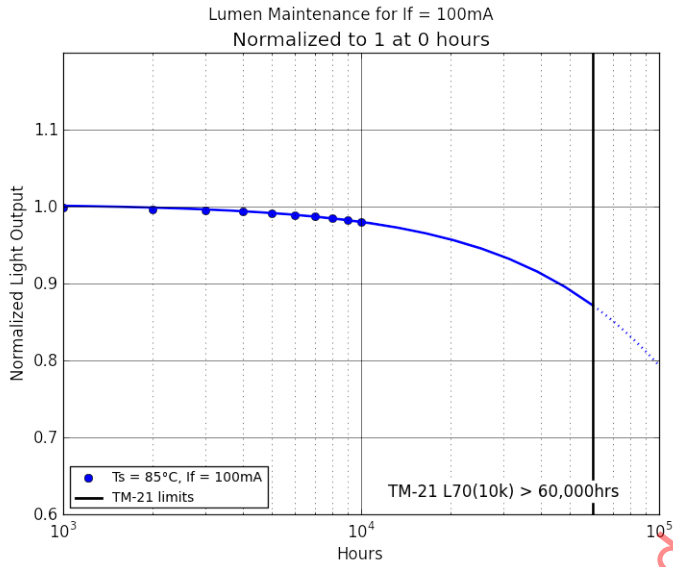

**Delta u'v' for  $I_f = 100\text{mA}$**

	0hrs	1000hrs	2000hrs	3000hrs	4000hrs	5000hrs	6000hrs	7000hrs	8000hrs	9000hrs	10000hrs
median =	0.0000	0.0005	0.0007	0.0009	0.0012	0.0014	0.0017	0.0021	0.0023	0.0028	0.0031
Ts=Tair=85°C average =	0.0000	0.0005	0.0007	0.0009	0.0012	0.0014	0.0017	0.0021	0.0023	0.0028	0.0031
st dev =	0.0000	0.0002	0.0001	0.0001	0.0002	0.0002	0.0003	0.0002	0.0002	0.0002	0.0002
min =	0.0000	0.0002	0.0005	0.0007	0.0010	0.0012	0.0013	0.0019	0.0021	0.0025	0.0028
max =	0.0000	0.0009	0.0011	0.0014	0.0017	0.0020	0.0022	0.0025	0.0028	0.0032	0.0035

This report is provided to HXMM

**Normalized Flux Statistics for  $I_f = 120\text{mA}$**

	0hrs	1000hrs	2000hrs	3000hrs	4000hrs	5000hrs	6000hrs	7000hrs	8000hrs	9000hrs	10000hrs	alpha	B	L70
median =	1.0000	0.9969	0.9944	0.9920	0.9882	0.9850	0.9833	0.9805	0.9782	0.9756	0.9730			
Ts=Tair=115°C average =	1.0000	0.9973	0.9939	0.9912	0.9879	0.9848	0.9831	0.9808	0.9785	0.9756	0.9728	2.4816e-06	0.9977	142,789
st dev =	0.0000	0.0018	0.0021	0.0025	0.0031	0.0035	0.0035	0.0036	0.0037	0.0038	0.0040	TM-21 L70(10k) > 60,000hrs		
min =	1.0000	0.9945	0.9904	0.9867	0.9824	0.9778	0.9762	0.9736	0.9715	0.9691	0.9659			
max =	1.0000	1.0008	0.9984	0.9953	0.9929	0.9913	0.9889	0.9866	0.9842	0.9818	0.9788			
median =	1.0000	0.9984	0.9961	0.9944	0.9920	0.9890	0.9866	0.9841	0.9824	0.9797	0.9771			
Ts=Tair=105°C average =	1.0000	0.9985	0.9960	0.9942	0.9919	0.9895	0.9870	0.9847	0.9824	0.9796	0.9770	2.5336e-06	1.0022	141,655
st dev =	0.0000	0.0017	0.0016	0.0016	0.0016	0.0018	0.0020	0.0023	0.0028	0.0031	0.0032	TM-21 L70(10k) > 60,000hrs		
min =	1.0000	0.9952	0.9929	0.9907	0.9890	0.9859	0.9835	0.9811	0.9780	0.9740	0.9725			
max =	1.0000	1.0016	0.9984	0.9976	0.9952	0.9936	0.9920	0.9904	0.9888	0.9857	0.9833			

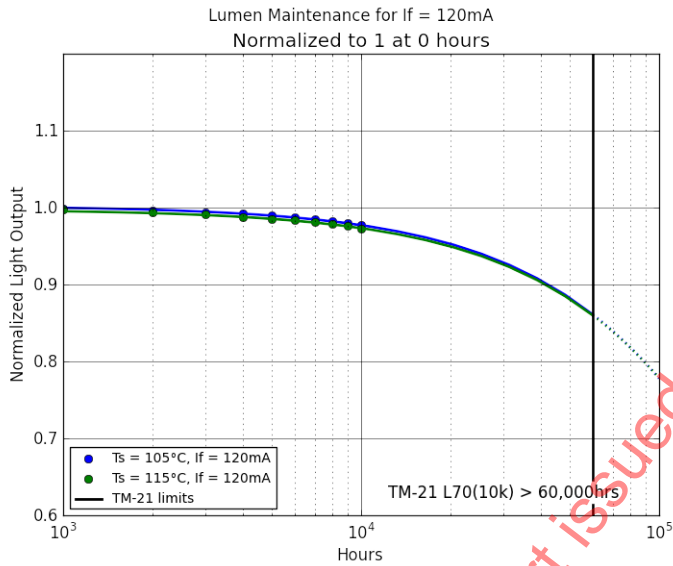

**Delta u'v' for  $I_f = 120\text{mA}$**

	0hrs	1000hrs	2000hrs	3000hrs	4000hrs	5000hrs	6000hrs	7000hrs	8000hrs	9000hrs	10000hrs
median =	0.0000	0.0007	0.0009	0.0013	0.0014	0.0017	0.0022	0.0024	0.0026	0.0028	0.0031
Ts=Tair=115°C average =	0.0000	0.0007	0.0010	0.0013	0.0015	0.0018	0.0021	0.0024	0.0026	0.0028	0.0032
st dev =	0.0000	0.0001	0.0001	0.0001	0.0002	0.0002	0.0002	0.0002	0.0002	0.0002	0.0002
min =	0.0000	0.0005	0.0008	0.0011	0.0013	0.0015	0.0019	0.0023	0.0023	0.0025	0.0029
max =	0.0000	0.0010	0.0013	0.0017	0.0020	0.0023	0.0025	0.0029	0.0031	0.0033	0.0037
median =	0.0000	0.0006	0.0007	0.0011	0.0013	0.0017	0.0019	0.0021	0.0024	0.0027	0.0030
Ts=Tair=105°C average =	0.0000	0.0006	0.0008	0.0011	0.0013	0.0017	0.0019	0.0022	0.0025	0.0028	0.0030
st dev =	0.0000	0.0002	0.0002	0.0002	0.0003	0.0003	0.0002	0.0003	0.0003	0.0003	0.0003
min =	0.0000	0.0002	0.0006	0.0009	0.0008	0.0012	0.0017	0.0019	0.0020	0.0022	0.0024
max =	0.0000	0.0013	0.0014	0.0020	0.0024	0.0027	0.0028	0.0031	0.0035	0.0038	0.0042

**Normalized Flux Statistics for  $I_f = 150\text{mA}$**

	0hrs	1000hrs	2000hrs	3000hrs	4000hrs	5000hrs	6000hrs	7000hrs	8000hrs	9000hrs	10000hrs	alpha	B	L70
median =	1.0000	0.9961	0.9929	0.9902	0.9867	0.9837	0.9813	0.9791	0.9762	0.9741	0.9714			
Ts=Tair=105°C average =	1.0000	0.9965	0.9934	0.9904	0.9870	0.9840	0.9812	0.9787	0.9761	0.9733	0.9703	2.7566e-06	0.9977	128,541
st dev =	0.0000	0.0017	0.0018	0.0021	0.0022	0.0024	0.0022	0.0023	0.0024	0.0026	0.0028	TM-21 L70(10k) > 60,000hrs		
min =	1.0000	0.9942	0.9904	0.9866	0.9838	0.9806	0.9780	0.9741	0.9715	0.9683	0.9651			
max =	1.0000	1.0013	0.9980	0.9954	0.9935	0.9895	0.9852	0.9830	0.9810	0.9784	0.9758			

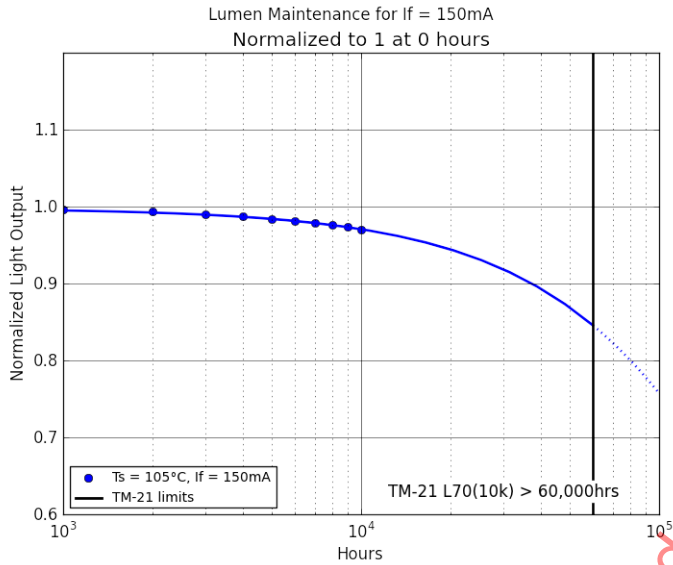

**Delta u'v' for  $I_f = 150\text{mA}$**

	0hrs	1000hrs	2000hrs	3000hrs	4000hrs	5000hrs	6000hrs	7000hrs	8000hrs	9000hrs	10000hrs
median =	0.0000	0.0008	0.0011	0.0014	0.0019	0.0021	0.0023	0.0026	0.0029	0.0032	0.0036
Ts=Tair=105°C average =	0.0000	0.0008	0.0011	0.0014	0.0019	0.0021	0.0022	0.0026	0.0029	0.0032	0.0036
st dev =	0.0000	0.0001	0.0001	0.0001	0.0001	0.0001	0.0001	0.0001	0.0001	0.0001	0.0001
min =	0.0000	0.0006	0.0009	0.0013	0.0017	0.0018	0.0021	0.0023	0.0027	0.0030	0.0033
max =	0.0000	0.0010	0.0012	0.0016	0.0021	0.0023	0.0025	0.0028	0.0030	0.0034	0.0040

This report is provided to HXM

**Normalized Flux Statistics for  $I_f = 180\text{mA}$**

	0hrs	1000hrs	2000hrs	3000hrs	4000hrs	5000hrs	6000hrs	7000hrs	8000hrs	9000hrs	10000hrs	alpha	B	L70
median =	1.0000	0.9945	0.9912	0.9888	0.9848	0.9818	0.9786	0.9752	0.9724	0.9692	0.9662			
Ts=Tair=115°C average =	1.0000	0.9949	0.9917	0.9887	0.9849	0.9816	0.9784	0.9753	0.9724	0.9692	0.9659	3.2016e-06	0.9974	110,606
st dev =	0.0000	0.0018	0.0022	0.0023	0.0024	0.0026	0.0029	0.0029	0.0024	0.0024	0.0021	TM-21 L70(10k) > 60,000hrs		
min =	1.0000	0.9917	0.9873	0.9846	0.9791	0.9757	0.9719	0.9680	0.9658	0.9631	0.9609			
max =	1.0000	0.9989	0.9972	0.9949	0.9898	0.9864	0.9835	0.9801	0.9761	0.9733	0.9690			

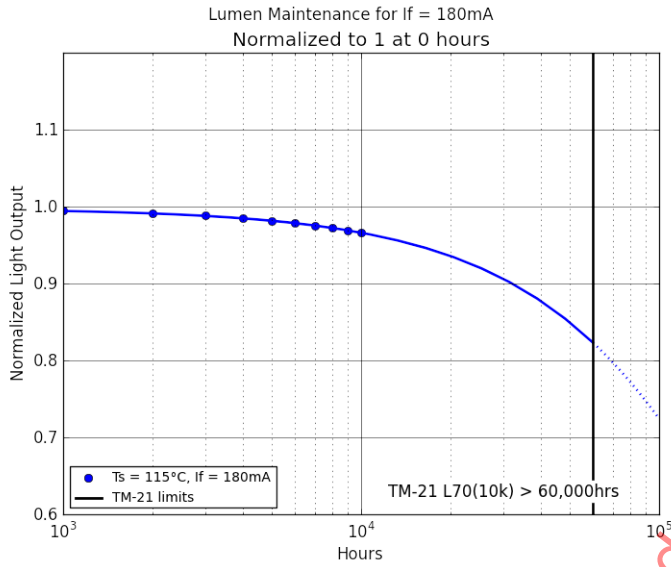

**Delta u'v' for  $I_f = 180\text{mA}$**

	0hrs	1000hrs	2000hrs	3000hrs	4000hrs	5000hrs	6000hrs	7000hrs	8000hrs	9000hrs	10000hrs
median =	0.0000	0.0008	0.0010	0.0015	0.0019	0.0021	0.0025	0.0028	0.0029	0.0031	0.0035
Ts=Tair=115°C average =	0.0000	0.0008	0.0011	0.0015	0.0019	0.0021	0.0025	0.0028	0.0029	0.0031	0.0035
st dev =	0.0000	0.0001	0.0002	0.0002	0.0002	0.0002	0.0002	0.0001	0.0001	0.0002	0.0002
min =	0.0000	0.0005	0.0008	0.0013	0.0015	0.0017	0.0023	0.0026	0.0027	0.0028	0.0030
max =	0.0000	0.0012	0.0015	0.0019	0.0023	0.0025	0.0029	0.0032	0.0033	0.0035	0.0039

This report is reserved to HXM

**Luminous Flux [lm] data for tested units**

$T_s = T_{air} = 55^\circ\text{C}$ ,  $I_f = 65\text{mA}$ ;  $T_s \geq 53^\circ\text{C}$  and  $T_{air} \geq 50^\circ\text{C}$  in compliance with LM-80-15

	CCT (t=0)	0hrs	1000hrs	2000hrs	3000hrs	4000hrs	5000hrs	6000hrs	7000hrs	8000hrs	9000hrs	10000hrs
1	3117K	72.490	72.770	72.730	72.720	72.600	72.450	72.370	72.230	72.010	71.760	71.540
2	3115K	72.320	72.550	72.490	72.410	72.300	72.250	72.230	72.150	72.040	71.910	71.770
3	3106K	72.840	72.940	72.910	72.830	72.760	72.670	72.630	72.610	72.520	72.420	72.270
4	3104K	72.790	73.130	73.080	73.070	72.920	72.850	72.730	72.580	72.480	72.330	72.240
5	3088K	73.240	73.430	73.290	73.220	73.200	73.090	72.970	72.860	72.790	72.630	72.400
6	3123K	72.120	72.470	72.440	72.380	72.260	72.200	72.030	71.860	71.680	71.520	71.450
7	3085K	72.660	72.930	72.850	72.840	72.630	72.620	72.470	72.420	72.300	72.070	71.910
8	3126K	72.960	73.220	73.140	73.030	72.990	72.880	72.750	72.600	72.560	72.520	72.440
9	3101K	73.140	73.430	73.370	73.340	73.190	73.150	73.050	72.860	72.650	72.450	72.300
10	3139K	73.820	74.200	74.100	74.040	73.960	73.930	73.710	73.570	73.420	73.290	73.080
11	3106K	73.070	73.340	73.260	73.160	73.150	73.050	72.870	72.730	72.470	72.290	72.090
12	3134K	70.820	71.090	71.020	70.890	70.850	70.750	70.580	70.540	70.390	70.270	70.130
13	3124K	70.900	71.140	71.090	71.080	70.980	70.890	70.820	70.710	70.680	70.670	70.630
14	3136K	72.000	72.220	72.160	72.130	71.970	71.810	71.770	71.570	71.330	71.210	71.120
15	3107K	73.470	73.570	73.500	73.440	73.390	73.270	73.110	73.020	72.830	72.730	72.570
16	3100K	72.310	72.570	72.460	72.400	72.300	72.170	72.090	71.930	71.780	71.630	71.500
17	3117K	72.930	73.210	73.150	73.080	72.980	72.870	72.680	72.550	72.450	72.280	72.200
18	3098K	73.160	73.390	73.320	73.230	73.120	73.060	72.880	72.680	72.600	72.440	72.340
19	3142K	71.640	72.010	71.960	71.900	71.780	71.670	71.570	71.450	71.340	71.190	71.070
20	3103K	73.540	73.810	73.710	73.650	73.560	73.350	73.330	73.270	73.180	73.040	72.900
21	3105K	72.790	73.100	73.080	73.060	72.860	72.780	72.660	72.470	72.440	72.290	72.160
22	3121K	72.370	72.540	72.480	72.420	72.380	72.230	72.150	72.020	71.850	71.690	71.540
23	2965K	73.800	74.000	73.980	73.880	73.760	73.650	73.550	73.370	73.220	73.120	72.960
24	3101K	73.060	73.330	73.280	73.240	73.080	73.030	72.910	72.880	72.710	72.650	72.470
25	3104K	70.290	70.470	70.460	70.450	70.270	70.110	70.090	69.980	69.740	69.610	69.560

**Normalized Luminous Flux data for tested units**

$T_s = T_{air} = 55^\circ\text{C}$ ,  $I_f = 65\text{mA}$ ;  $T_s \geq 53^\circ\text{C}$  and  $T_{air} \geq 50^\circ\text{C}$  in compliance with LM-80-15

	CCT (t=0)	0hrs	1000hrs	2000hrs	3000hrs	4000hrs	5000hrs	6000hrs	7000hrs	8000hrs	9000hrs	10000hrs
1	3117K	1.0000	1.0039	1.0033	1.0032	1.0015	0.9994	0.9983	0.9964	0.9934	0.9899	0.9869
2	3115K	1.0000	1.0032	1.0024	1.0012	0.9997	0.9990	0.9988	0.9976	0.9961	0.9943	0.9924
3	3106K	1.0000	1.0014	1.0010	0.9999	0.9989	0.9977	0.9971	0.9968	0.9956	0.9942	0.9922
4	3104K	1.0000	1.0047	1.0040	1.0038	1.0018	1.0008	0.9992	0.9971	0.9957	0.9937	0.9924
5	3088K	1.0000	1.0026	1.0007	0.9997	0.9995	0.9980	0.9963	0.9948	0.9939	0.9917	0.9885
6	3123K	1.0000	1.0049	1.0044	1.0036	1.0019	1.0011	0.9988	0.9964	0.9939	0.9917	0.9907
7	3085K	1.0000	1.0037	1.0026	1.0025	0.9996	0.9994	0.9974	0.9967	0.9950	0.9919	0.9897
8	3126K	1.0000	1.0036	1.0025	1.0010	1.0004	0.9989	0.9971	0.9951	0.9945	0.9940	0.9929
9	3101K	1.0000	1.0040	1.0031	1.0027	1.0007	1.0001	0.9988	0.9962	0.9933	0.9906	0.9885
10	3139K	1.0000	1.0051	1.0038	1.0030	1.0019	1.0015	0.9985	0.9966	0.9946	0.9928	0.9900
11	3106K	1.0000	1.0037	1.0026	1.0012	1.0011	0.9997	0.9973	0.9953	0.9918	0.9893	0.9866
12	3134K	1.0000	1.0038	1.0028	1.0010	1.0004	0.9990	0.9966	0.9960	0.9939	0.9922	0.9903
13	3124K	1.0000	1.0034	1.0027	1.0025	1.0011	0.9999	0.9989	0.9973	0.9969	0.9968	0.9962
14	3136K	1.0000	1.0031	1.0022	1.0018	0.9996	0.9974	0.9968	0.9940	0.9907	0.9890	0.9878
15	3107K	1.0000	1.0014	1.0004	0.9996	0.9989	0.9973	0.9951	0.9939	0.9913	0.9899	0.9878
16	3100K	1.0000	1.0036	1.0021	1.0012	0.9999	0.9981	0.9970	0.9947	0.9927	0.9906	0.9888
17	3117K	1.0000	1.0038	1.0030	1.0021	1.0007	0.9992	0.9966	0.9948	0.9934	0.9911	0.9900
18	3098K	1.0000	1.0031	1.0022	1.0010	0.9995	0.9986	0.9962	0.9934	0.9923	0.9902	0.9888
19	3142K	1.0000	1.0052	1.0045	1.0036	1.0020	1.0004	0.9990	0.9973	0.9958	0.9937	0.9920
20	3103K	1.0000	1.0037	1.0023	1.0015	1.0003	0.9974	0.9971	0.9963	0.9951	0.9932	0.9913
21	3105K	1.0000	1.0043	1.0040	1.0037	1.0010	0.9999	0.9982	0.9956	0.9952	0.9931	0.9913
22	3121K	1.0000	1.0023	1.0015	1.0007	1.0001	0.9981	0.9970	0.9952	0.9928	0.9906	0.9885
23	2965K	1.0000	1.0027	1.0024	1.0011	0.9995	0.9980	0.9966	0.9942	0.9921	0.9908	0.9886
24	3101K	1.0000	1.0037	1.0030	1.0025	1.0003	0.9996	0.9979	0.9975	0.9952	0.9944	0.9919
25	3104K	1.0000	1.0026	1.0024	1.0023	0.9997	0.9974	0.9972	0.9956	0.9922	0.9903	0.9896

**CIE 1976 u' data for tested units**

$T_s = T_{air} = 55^{\circ}\text{C}$ ,  $I_f = 65\text{mA}$ ;  $T_s \geq 53^{\circ}\text{C}$  and  $T_{air} \geq 50^{\circ}\text{C}$  in compliance with LM-80-15

	CCT (t=0)	0hrs	1000hrs	2000hrs	3000hrs	4000hrs	5000hrs	6000hrs	7000hrs	8000hrs	9000hrs	10000hrs
1	3117K	0.2469	0.2467	0.2469	0.2468	0.2465	0.2464	0.2466	0.2465	0.2463	0.2460	0.2460
2	3115K	0.2467	0.2463	0.2465	0.2462	0.2460	0.2459	0.2461	0.2461	0.2458	0.2455	0.2456
3	3106K	0.2473	0.2471	0.2472	0.2470	0.2468	0.2466	0.2469	0.2468	0.2465	0.2461	0.2463
4	3104K	0.2472	0.2469	0.2471	0.2470	0.2466	0.2466	0.2468	0.2467	0.2465	0.2461	0.2461
5	3088K	0.2480	0.2478	0.2480	0.2479	0.2476	0.2475	0.2477	0.2476	0.2473	0.2470	0.2471
6	3123K	0.2465	0.2463	0.2464	0.2464	0.2460	0.2459	0.2462	0.2461	0.2456	0.2454	0.2455
7	3085K	0.2481	0.2478	0.2480	0.2479	0.2476	0.2473	0.2477	0.2476	0.2472	0.2469	0.2470
8	3126K	0.2465	0.2463	0.2464	0.2463	0.2460	0.2459	0.2461	0.2460	0.2457	0.2454	0.2455
9	3101K	0.2471	0.2468	0.2470	0.2469	0.2466	0.2465	0.2467	0.2466	0.2463	0.2460	0.2462
10	3139K	0.2463	0.2460	0.2461	0.2460	0.2457	0.2456	0.2459	0.2457	0.2454	0.2450	0.2452
11	3106K	0.2473	0.2471	0.2473	0.2473	0.2468	0.2467	0.2471	0.2469	0.2465	0.2462	0.2463
12	3134K	0.2463	0.2462	0.2463	0.2463	0.2458	0.2458	0.2461	0.2459	0.2457	0.2453	0.2453
13	3124K	0.2465	0.2459	0.2460	0.2461	0.2455	0.2454	0.2459	0.2457	0.2454	0.2451	0.2451
14	3136K	0.2457	0.2455	0.2456	0.2456	0.2452	0.2451	0.2454	0.2452	0.2449	0.2447	0.2446
15	3107K	0.2470	0.2467	0.2468	0.2467	0.2463	0.2465	0.2467	0.2465	0.2462	0.2459	0.2458
16	3100K	0.2473	0.2471	0.2472	0.2471	0.2467	0.2469	0.2470	0.2468	0.2464	0.2462	0.2461
17	3117K	0.2469	0.2467	0.2467	0.2466	0.2462	0.2464	0.2466	0.2464	0.2460	0.2457	0.2457
18	3098K	0.2473	0.2471	0.2472	0.2471	0.2468	0.2469	0.2471	0.2469	0.2466	0.2463	0.2462
19	3142K	0.2456	0.2454	0.2455	0.2455	0.2451	0.2452	0.2454	0.2452	0.2448	0.2446	0.2446
20	3103K	0.2476	0.2474	0.2474	0.2474	0.2471	0.2472	0.2473	0.2472	0.2468	0.2466	0.2465
21	3105K	0.2472	0.2471	0.2472	0.2472	0.2468	0.2469	0.2471	0.2469	0.2465	0.2463	0.2463
22	3121K	0.2464	0.2462	0.2463	0.2462	0.2459	0.2460	0.2461	0.2459	0.2456	0.2452	0.2452
23	2965K	0.2512	0.2509	0.2511	0.2510	0.2506	0.2508	0.2509	0.2507	0.2503	0.2501	0.2500
24	3101K	0.2475	0.2473	0.2475	0.2474	0.2471	0.2472	0.2474	0.2472	0.2469	0.2466	0.2466
25	3104K	0.2476	0.2473	0.2474	0.2474	0.2470	0.2471	0.2473	0.2471	0.2467	0.2464	0.2464

**CIE 1976 v' data for tested units**

$T_s = T_{air} = 55^{\circ}\text{C}$ ,  $I_f = 65\text{mA}$ ;  $T_s \geq 53^{\circ}\text{C}$  and  $T_{air} \geq 50^{\circ}\text{C}$  in compliance with LM-80-15

	CCT (t=0)	0hrs	1000hrs	2000hrs	3000hrs	4000hrs	5000hrs	6000hrs	7000hrs	8000hrs	9000hrs	10000hrs
1	3117K	0.5179	0.5178	0.5176	0.5174	0.5170	0.5168	0.5164	0.5162	0.5159	0.5158	0.5156
2	3115K	0.5189	0.5185	0.5184	0.5182	0.5179	0.5177	0.5172	0.5169	0.5166	0.5166	0.5164
3	3106K	0.5179	0.5177	0.5175	0.5174	0.5170	0.5168	0.5164	0.5161	0.5158	0.5158	0.5155
4	3104K	0.5185	0.5182	0.5180	0.5179	0.5175	0.5174	0.5169	0.5167	0.5165	0.5164	0.5161
5	3088K	0.5179	0.5178	0.5176	0.5175	0.5171	0.5169	0.5165	0.5162	0.5159	0.5159	0.5156
6	3123K	0.5185	0.5182	0.5181	0.5179	0.5175	0.5174	0.5169	0.5167	0.5164	0.5163	0.5161
7	3085K	0.5179	0.5177	0.5175	0.5174	0.5170	0.5168	0.5163	0.5161	0.5158	0.5157	0.5155
8	3126K	0.5181	0.5179	0.5177	0.5176	0.5172	0.5171	0.5166	0.5163	0.5161	0.5160	0.5158
9	3101K	0.5193	0.5191	0.5189	0.5189	0.5185	0.5183	0.5179	0.5176	0.5173	0.5172	0.5171
10	3139K	0.5170	0.5167	0.5165	0.5165	0.5161	0.5159	0.5155	0.5152	0.5149	0.5148	0.5146
11	3106K	0.5179	0.5178	0.5175	0.5175	0.5171	0.5169	0.5166	0.5162	0.5159	0.5158	0.5155
12	3134K	0.5177	0.5175	0.5174	0.5173	0.5169	0.5167	0.5163	0.5160	0.5157	0.5156	0.5153
13	3124K	0.5184	0.5177	0.5175	0.5175	0.5170	0.5168	0.5164	0.5161	0.5159	0.5158	0.5154
14	3136K	0.5195	0.5194	0.5192	0.5191	0.5187	0.5186	0.5183	0.5177	0.5176	0.5175	0.5171
15	3107K	0.5188	0.5185	0.5183	0.5182	0.5178	0.5177	0.5174	0.5170	0.5168	0.5167	0.5162
16	3100K	0.5187	0.5185	0.5183	0.5182	0.5178	0.5176	0.5173	0.5169	0.5166	0.5165	0.5161
17	3117K	0.5178	0.5174	0.5172	0.5170	0.5167	0.5164	0.5162	0.5158	0.5155	0.5154	0.5150
18	3098K	0.5191	0.5190	0.5188	0.5185	0.5182	0.5179	0.5177	0.5173	0.5170	0.5169	0.5165
19	3142K	0.5191	0.5190	0.5188	0.5188	0.5184	0.5181	0.5178	0.5175	0.5172	0.5171	0.5168
20	3103K	0.5172	0.5170	0.5168	0.5168	0.5164	0.5160	0.5158	0.5155	0.5152	0.5151	0.5147
21	3105K	0.5184	0.5183	0.5180	0.5180	0.5176	0.5173	0.5170	0.5167	0.5164	0.5163	0.5159
22	3121K	0.5191	0.5189	0.5187	0.5186	0.5183	0.5180	0.5177	0.5174	0.5170	0.5168	0.5164
23	2965K	0.5245	0.5243	0.5240	0.5240	0.5237	0.5233	0.5231	0.5228	0.5224	0.5224	0.5220
24	3101K	0.5179	0.5178	0.5176	0.5175	0.5172	0.5168	0.5166	0.5163	0.5161	0.5159	0.5156
25	3104K	0.5171	0.5169	0.5167	0.5167	0.5163	0.5159	0.5158	0.5154	0.5151	0.5150	0.5146

**Delta u'v' data for tested units**

$T_s = T_{air} = 55^\circ\text{C}$ ,  $I_f = 65\text{mA}$ ;  $T_s \geq 53^\circ\text{C}$  and  $T_{air} \geq 50^\circ\text{C}$  in compliance with LM-80-15

	CCT (t=0)	0hrs	1000hrs	2000hrs	3000hrs	4000hrs	5000hrs	6000hrs	7000hrs	8000hrs	9000hrs	10000hrs
1	3117K	0.0000	0.0002	0.0003	0.0005	0.0010	0.0012	0.0015	0.0017	0.0021	0.0023	0.0025
2	3115K	0.0000	0.0006	0.0005	0.0009	0.0012	0.0014	0.0018	0.0021	0.0025	0.0026	0.0027
3	3106K	0.0000	0.0003	0.0004	0.0006	0.0010	0.0013	0.0016	0.0019	0.0022	0.0024	0.0026
4	3104K	0.0000	0.0004	0.0005	0.0006	0.0012	0.0013	0.0016	0.0019	0.0021	0.0024	0.0026
5	3088K	0.0000	0.0002	0.0003	0.0004	0.0009	0.0011	0.0014	0.0017	0.0021	0.0022	0.0025
6	3123K	0.0000	0.0004	0.0004	0.0006	0.0011	0.0013	0.0016	0.0018	0.0023	0.0025	0.0026
7	3085K	0.0000	0.0004	0.0004	0.0005	0.0010	0.0014	0.0016	0.0019	0.0023	0.0025	0.0026
8	3126K	0.0000	0.0003	0.0004	0.0005	0.0010	0.0012	0.0016	0.0019	0.0022	0.0024	0.0025
9	3101K	0.0000	0.0004	0.0004	0.0004	0.0009	0.0012	0.0015	0.0018	0.0022	0.0024	0.0024
10	3139K	0.0000	0.0004	0.0005	0.0006	0.0011	0.0013	0.0016	0.0019	0.0023	0.0026	0.0026
11	3106K	0.0000	0.0002	0.0004	0.0004	0.0009	0.0012	0.0013	0.0017	0.0022	0.0024	0.0026
12	3134K	0.0000	0.0002	0.0003	0.0004	0.0009	0.0011	0.0014	0.0017	0.0021	0.0023	0.0026
13	3124K	0.0000	0.0009	0.0010	0.0010	0.0017	0.0019	0.0021	0.0024	0.0027	0.0030	0.0033
14	3136K	0.0000	0.0002	0.0003	0.0004	0.0009	0.0011	0.0012	0.0019	0.0021	0.0022	0.0026
15	3107K	0.0000	0.0004	0.0005	0.0007	0.0012	0.0012	0.0014	0.0019	0.0022	0.0024	0.0029
16	3100K	0.0000	0.0003	0.0004	0.0005	0.0011	0.0012	0.0014	0.0019	0.0023	0.0025	0.0029
17	3117K	0.0000	0.0004	0.0006	0.0009	0.0013	0.0015	0.0016	0.0021	0.0025	0.0027	0.0030
18	3098K	0.0000	0.0002	0.0003	0.0006	0.0010	0.0013	0.0014	0.0018	0.0022	0.0024	0.0028
19	3142K	0.0000	0.0002	0.0003	0.0003	0.0009	0.0011	0.0013	0.0016	0.0021	0.0022	0.0025
20	3103K	0.0000	0.0003	0.0004	0.0004	0.0009	0.0013	0.0014	0.0017	0.0022	0.0023	0.0027
21	3105K	0.0000	0.0001	0.0004	0.0004	0.0009	0.0011	0.0014	0.0017	0.0021	0.0023	0.0027
22	3121K	0.0000	0.0003	0.0004	0.0005	0.0009	0.0012	0.0014	0.0018	0.0022	0.0026	0.0030
23	2965K	0.0000	0.0004	0.0005	0.0005	0.0010	0.0013	0.0014	0.0018	0.0023	0.0024	0.0028
24	3101K	0.0000	0.0002	0.0003	0.0004	0.0008	0.0011	0.0013	0.0016	0.0019	0.0022	0.0025
25	3104K	0.0000	0.0004	0.0004	0.0004	0.0010	0.0013	0.0013	0.0018	0.0022	0.0024	0.0028

**Forward Voltage [V] data for tested units**

$T_s = T_{air} = 55^\circ\text{C}$ ,  $I_f = 65\text{mA}$ ;  $T_s \geq 53^\circ\text{C}$  and  $T_{air} \geq 50^\circ\text{C}$  in compliance with LM-80-15

	CCT (t=0)	0hrs	1000hrs	2000hrs	3000hrs	4000hrs	5000hrs	6000hrs	7000hrs	8000hrs	9000hrs	10000hrs
1	3117K	5.546	5.548	5.556	5.553	5.551	5.546	5.553	5.546	5.557	5.545	5.547
2	3115K	5.577	5.584	5.582	5.588	5.584	5.575	5.599	5.575	5.574	5.575	5.575
3	3106K	5.642	5.620	5.613	5.620	5.616	5.611	5.620	5.617	5.608	5.607	5.612
4	3104K	5.602	5.602	5.597	5.606	5.678	5.597	5.601	5.596	5.592	5.594	5.598
5	3088K	5.705	5.611	5.603	5.607	5.602	5.596	5.605	5.595	5.596	5.596	5.596
6	3123K	5.567	5.584	5.568	5.579	5.573	5.577	5.575	5.567	5.564	5.569	5.565
7	3085K	5.565	5.568	5.570	5.582	5.571	5.607	5.576	5.565	5.563	5.564	5.567
8	3126K	5.595	5.595	5.596	5.611	5.601	5.598	5.596	5.596	5.592	5.590	5.594
9	3101K	5.602	5.567	5.559	5.587	5.568	5.561	5.563	5.557	5.555	5.558	5.558
10	3139K	5.697	5.744	5.615	5.627	5.616	5.676	5.616	5.612	5.609	5.609	5.612
11	3106K	5.580	5.627	5.577	5.586	5.581	5.637	5.577	5.584	5.574	5.572	5.574
12	3134K	5.606	5.566	5.567	5.576	5.570	5.568	5.566	5.563	5.561	5.563	5.571
13	3124K	5.589	5.591	5.595	5.607	5.640	5.705	5.594	5.590	5.591	5.589	5.590
14	3136K	5.601	5.587	5.585	5.595	5.589	5.583	5.587	5.581	5.578	5.581	5.583
15	3107K	5.575	5.577	5.575	5.584	5.585	5.586	5.581	5.574	5.573	5.572	5.577
16	3100K	5.577	5.728	5.555	5.566	5.557	5.562	5.558	5.555	5.551	5.551	5.553
17	3117K	5.593	5.594	5.598	5.607	5.600	5.612	5.595	5.594	5.591	5.591	5.594
18	3098K	5.566	5.568	5.567	5.577	5.572	5.572	5.572	5.566	5.562	5.563	5.567
19	3142K	5.797	5.610	5.595	5.646	5.596	5.637	5.592	5.590	5.586	5.586	5.589
20	3103K	5.593	5.603	5.597	5.606	5.598	5.646	5.601	5.596	5.594	5.592	5.595
21	3105K	5.578	5.580	5.582	5.590	5.593	5.586	5.582	5.581	5.577	5.578	5.579
22	3121K	5.574	5.574	5.575	5.583	5.577	5.576	5.575	5.570	5.570	5.569	5.570
23	2965K	5.599	5.603	5.609	5.611	5.832	5.602	5.599	5.597	5.595	5.596	5.602
24	3101K	5.576	5.601	5.593	5.587	5.585	5.582	5.588	5.575	5.574	5.571	5.578
25	3104K	5.595	5.602	5.593	5.608	5.598	5.614	5.596	5.595	5.612	5.590	5.601

**Luminous Flux [lm] data for tested units**

$T_s = T_{air} = 105^{\circ}\text{C}$ ,  $I_f = 65\text{mA}$ ;  $T_s \geq 103^{\circ}\text{C}$  and  $T_{air} \geq 100^{\circ}\text{C}$  in compliance with LM-80-15

	CCT (t=0)	0hrs	1000hrs	2000hrs	3000hrs	4000hrs	5000hrs	6000hrs	7000hrs	8000hrs	9000hrs	10000hrs
1	3114K	73.390	73.610	73.550	73.500	73.360	73.310	73.170	73.030	72.890	72.790	72.730
2	3090K	72.100	72.280	72.150	72.110	72.040	71.800	71.690	71.520	71.350	71.150	71.060
3	3109K	73.490	73.600	73.500	73.380	73.210	73.040	72.910	72.810	72.680	72.520	72.260
4	3118K	73.570	73.710	73.590	73.480	73.300	73.220	73.010	72.880	72.700	72.530	72.380
5	2947K	73.070	73.160	73.020	72.910	72.700	72.650	72.520	72.370	72.130	71.930	71.770
6	3104K	72.430	72.580	72.550	72.480	72.330	72.210	71.970	71.890	71.670	71.600	71.380
7	2920K	71.660	71.790	71.550	71.540	71.420	71.300	71.100	70.960	70.760	70.680	70.570
8	3117K	73.240	73.390	73.310	73.230	73.120	72.910	72.810	72.550	72.520	72.370	72.230
9	3117K	70.540	70.590	70.420	70.390	70.320	70.260	70.110	69.920	69.840	69.660	69.610
10	3126K	71.440	71.550	71.420	71.240	71.090	70.970	70.940	70.760	70.540	70.440	70.370
11	3089K	72.030	72.070	71.990	71.820	71.670	71.500	71.420	71.310	71.130	70.910	70.770
12	3091K	71.480	71.600	71.470	71.330	71.270	71.210	70.990	70.820	70.750	70.700	70.560
13	3127K	70.920	71.140	71.040	70.990	70.870	70.700	70.620	70.450	70.280	70.140	69.960
14	3117K	71.880	72.080	71.930	71.830	71.800	71.670	71.520	71.390	71.310	71.170	70.950
15	3085K	72.680	72.820	72.660	72.560	72.490	72.380	72.230	72.110	72.000	71.940	71.730
16	3096K	71.200	71.270	71.160	71.050	70.950	70.760	70.670	70.590	70.460	70.330	70.170
17	3106K	73.460	73.470	73.400	73.290	73.240	73.120	72.990	72.880	72.710	72.610	72.450
18	3081K	72.870	72.900	72.820	72.690	72.630	72.480	72.320	72.200	72.100	72.010	71.770
19	3100K	72.430	72.480	72.370	72.210	72.030	71.890	71.820	71.590	71.320	71.290	71.210
20	3082K	71.610	71.680	71.590	71.460	71.370	71.200	70.970	70.740	70.510	70.340	70.150
21	2961K	73.470	73.620	73.460	73.380	73.340	73.120	72.890	72.770	72.550	72.340	72.150
22	3101K	72.680	72.840	72.620	72.580	72.430	72.260	72.080	72.030	71.880	71.790	71.660
23	3099K	72.430	72.560	72.420	72.390	72.270	72.100	71.910	71.780	71.750	71.620	71.400
24	3121K	72.650	72.860	72.820	72.730	72.590	72.500	72.350	72.270	72.090	71.930	71.820
25	3107K	72.460	72.570	72.470	72.370	72.240	72.120	71.940	71.890	71.660	71.450	71.280

**Normalized Luminous Flux data for tested units**

$T_s = T_{air} = 105^{\circ}\text{C}$ ,  $I_f = 65\text{mA}$ ;  $T_s \geq 103^{\circ}\text{C}$  and  $T_{air} \geq 100^{\circ}\text{C}$  in compliance with LM-80-15

	CCT (t=0)	0hrs	1000hrs	2000hrs	3000hrs	4000hrs	5000hrs	6000hrs	7000hrs	8000hrs	9000hrs	10000hrs
1	3114K	1.0000	1.0030	1.0022	1.0015	0.9996	0.9989	0.9970	0.9951	0.9932	0.9918	0.9910
2	3090K	1.0000	1.0025	1.0007	1.0001	0.9992	0.9958	0.9943	0.9920	0.9896	0.9868	0.9856
3	3109K	1.0000	1.0015	1.0001	0.9985	0.9962	0.9939	0.9921	0.9907	0.9890	0.9868	0.9833
4	3118K	1.0000	1.0019	1.0003	0.9988	0.9963	0.9952	0.9924	0.9906	0.9882	0.9859	0.9838
5	2947K	1.0000	1.0012	0.9993	0.9978	0.9949	0.9943	0.9925	0.9904	0.9871	0.9844	0.9822
6	3104K	1.0000	1.0021	1.0017	1.0007	0.9986	0.9970	0.9936	0.9925	0.9895	0.9885	0.9855
7	2920K	1.0000	1.0018	0.9985	0.9983	0.9967	0.9950	0.9922	0.9902	0.9874	0.9863	0.9848
8	3117K	1.0000	1.0020	1.0010	0.9999	0.9984	0.9955	0.9941	0.9906	0.9902	0.9881	0.9862
9	3117K	1.0000	1.0007	0.9983	0.9979	0.9969	0.9960	0.9939	0.9912	0.9901	0.9875	0.9868
10	3126K	1.0000	1.0015	0.9997	0.9972	0.9951	0.9934	0.9930	0.9905	0.9874	0.9860	0.9850
11	3089K	1.0000	1.0006	0.9994	0.9971	0.9950	0.9926	0.9915	0.9900	0.9875	0.9845	0.9825
12	3091K	1.0000	1.0017	0.9999	0.9979	0.9971	0.9962	0.9931	0.9908	0.9898	0.9891	0.9871
13	3127K	1.0000	1.0031	1.0017	1.0010	0.9993	0.9969	0.9958	0.9934	0.9910	0.9890	0.9865
14	3117K	1.0000	1.0028	1.0007	0.9993	0.9989	0.9971	0.9950	0.9932	0.9921	0.9901	0.9871
15	3085K	1.0000	1.0019	0.9997	0.9983	0.9974	0.9959	0.9938	0.9922	0.9906	0.9898	0.9869
16	3096K	1.0000	1.0010	0.9994	0.9979	0.9965	0.9938	0.9926	0.9914	0.9896	0.9878	0.9855
17	3106K	1.0000	1.0001	0.9992	0.9977	0.9970	0.9954	0.9936	0.9921	0.9898	0.9884	0.9863
18	3081K	1.0000	1.0004	0.9993	0.9975	0.9967	0.9946	0.9925	0.9908	0.9894	0.9882	0.9849
19	3100K	1.0000	1.0007	0.9992	0.9970	0.9945	0.9925	0.9916	0.9884	0.9847	0.9843	0.9832
20	3082K	1.0000	1.0010	0.9997	0.9979	0.9966	0.9943	0.9911	0.9879	0.9846	0.9823	0.9796
21	2961K	1.0000	1.0020	0.9999	0.9988	0.9982	0.9952	0.9921	0.9905	0.9875	0.9846	0.9820
22	3101K	1.0000	1.0022	0.9992	0.9986	0.9966	0.9942	0.9917	0.9911	0.9890	0.9878	0.9860
23	3099K	1.0000	1.0018	0.9999	0.9994	0.9978	0.9954	0.9928	0.9910	0.9906	0.9888	0.9858
24	3121K	1.0000	1.0029	1.0023	1.0011	0.9992	0.9979	0.9959	0.9948	0.9923	0.9901	0.9886
25	3107K	1.0000	1.0015	1.0001	0.9988	0.9970	0.9953	0.9928	0.9921	0.9890	0.9861	0.9837

**CIE 1976 u' data for tested units**

$T_s = T_{air} = 105^\circ\text{C}$ ,  $I_f = 65\text{mA}$ ;  $T_s \geq 103^\circ\text{C}$  and  $T_{air} \geq 100^\circ\text{C}$  in compliance with LM-80-15

	CCT (t=0)	0hrs	1000hrs	2000hrs	3000hrs	4000hrs	5000hrs	6000hrs	7000hrs	8000hrs	9000hrs	10000hrs
1	3114K	0.2464	0.2461	0.2462	0.2461	0.2456	0.2459	0.2460	0.2459	0.2456	0.2452	0.2452
2	3090K	0.2481	0.2477	0.2478	0.2478	0.2474	0.2476	0.2477	0.2476	0.2472	0.2469	0.2469
3	3109K	0.2472	0.2469	0.2470	0.2470	0.2465	0.2467	0.2470	0.2468	0.2464	0.2461	0.2461
4	3118K	0.2468	0.2465	0.2466	0.2465	0.2461	0.2463	0.2465	0.2463	0.2459	0.2456	0.2456
5	2947K	0.2519	0.2515	0.2516	0.2515	0.2511	0.2513	0.2515	0.2513	0.2510	0.2507	0.2506
6	3104K	0.2474	0.2471	0.2472	0.2471	0.2467	0.2469	0.2471	0.2469	0.2466	0.2462	0.2462
7	2920K	0.2538	0.2535	0.2536	0.2535	0.2530	0.2533	0.2534	0.2533	0.2529	0.2526	0.2525
8	3117K	0.2467	0.2463	0.2464	0.2463	0.2458	0.2461	0.2463	0.2461	0.2458	0.2455	0.2454
9	3117K	0.2468	0.2467	0.2467	0.2465	0.2461	0.2464	0.2465	0.2464	0.2460	0.2457	0.2457
10	3126K	0.2470	0.2467	0.2468	0.2467	0.2463	0.2464	0.2466	0.2464	0.2461	0.2458	0.2457
11	3089K	0.2481	0.2478	0.2478	0.2478	0.2474	0.2476	0.2477	0.2475	0.2472	0.2468	0.2468
12	3091K	0.2477	0.2475	0.2475	0.2475	0.2470	0.2472	0.2474	0.2472	0.2469	0.2466	0.2466
13	3127K	0.2461	0.2458	0.2459	0.2458	0.2454	0.2456	0.2458	0.2456	0.2453	0.2449	0.2449
14	3117K	0.2459	0.2456	0.2456	0.2455	0.2452	0.2454	0.2455	0.2453	0.2450	0.2448	0.2447
15	3085K	0.2480	0.2476	0.2477	0.2477	0.2472	0.2474	0.2476	0.2474	0.2470	0.2467	0.2467
16	3096K	0.2477	0.2473	0.2474	0.2474	0.2469	0.2471	0.2472	0.2471	0.2467	0.2464	0.2464
17	3106K	0.2473	0.2470	0.2470	0.2470	0.2465	0.2468	0.2469	0.2467	0.2463	0.2460	0.2461
18	3081K	0.2482	0.2479	0.2480	0.2479	0.2474	0.2477	0.2478	0.2476	0.2473	0.2470	0.2469
19	3100K	0.2473	0.2469	0.2470	0.2469	0.2464	0.2466	0.2468	0.2466	0.2461	0.2459	0.2459
20	3082K	0.2483	0.2480	0.2481	0.2480	0.2476	0.2477	0.2479	0.2477	0.2475	0.2471	0.2471
21	2961K	0.2517	0.2513	0.2515	0.2514	0.2508	0.2510	0.2512	0.2510	0.2507	0.2504	0.2504
22	3101K	0.2474	0.2471	0.2471	0.2470	0.2466	0.2467	0.2469	0.2467	0.2464	0.2461	0.2462
23	3099K	0.2479	0.2476	0.2477	0.2476	0.2472	0.2473	0.2475	0.2473	0.2471	0.2467	0.2467
24	3121K	0.2471	0.2467	0.2468	0.2467	0.2463	0.2465	0.2466	0.2465	0.2462	0.2458	0.2458
25	3107K	0.2474	0.2471	0.2471	0.2470	0.2466	0.2467	0.2469	0.2467	0.2464	0.2461	0.2460

**CIE 1976 v' data for tested units**

$T_s = T_{air} = 105^\circ\text{C}$ ,  $I_f = 65\text{mA}$ ;  $T_s \geq 103^\circ\text{C}$  and  $T_{air} \geq 100^\circ\text{C}$  in compliance with LM-80-15

	CCT (t=0)	0hrs	1000hrs	2000hrs	3000hrs	4000hrs	5000hrs	6000hrs	7000hrs	8000hrs	9000hrs	10000hrs
1	3114K	0.5200	0.5197	0.5195	0.5192	0.5191	0.5187	0.5185	0.5182	0.5179	0.5177	0.5174
2	3090K	0.5172	0.5170	0.5166	0.5164	0.5162	0.5159	0.5157	0.5153	0.5150	0.5149	0.5145
3	3109K	0.5179	0.5176	0.5173	0.5172	0.5169	0.5166	0.5165	0.5162	0.5157	0.5156	0.5153
4	3118K	0.5181	0.5178	0.5175	0.5173	0.5170	0.5168	0.5166	0.5163	0.5160	0.5158	0.5154
5	2947K	0.5247	0.5244	0.5240	0.5239	0.5237	0.5234	0.5231	0.5228	0.5226	0.5225	0.5221
6	3104K	0.5178	0.5175	0.5171	0.5170	0.5167	0.5164	0.5162	0.5159	0.5156	0.5154	0.5151
7	2920K	0.5216	0.5213	0.5209	0.5208	0.5205	0.5202	0.5200	0.5197	0.5194	0.5192	0.5189
8	3117K	0.5186	0.5182	0.5179	0.5177	0.5175	0.5172	0.5170	0.5166	0.5164	0.5162	0.5159
9	3117K	0.5182	0.5180	0.5177	0.5175	0.5172	0.5169	0.5167	0.5164	0.5160	0.5159	0.5155
10	3126K	0.5163	0.5159	0.5156	0.5155	0.5152	0.5149	0.5147	0.5144	0.5142	0.5140	0.5136
11	3089K	0.5174	0.5169	0.5166	0.5165	0.5162	0.5159	0.5157	0.5153	0.5151	0.5148	0.5145
12	3091K	0.5186	0.5185	0.5180	0.5179	0.5177	0.5174	0.5172	0.5168	0.5166	0.5164	0.5161
13	3127K	0.5193	0.5190	0.5187	0.5185	0.5183	0.5180	0.5177	0.5174	0.5172	0.5169	0.5166
14	3117K	0.5214	0.5211	0.5208	0.5206	0.5204	0.5201	0.5199	0.5195	0.5193	0.5192	0.5188
15	3085K	0.5183	0.5180	0.5176	0.5175	0.5173	0.5170	0.5168	0.5164	0.5162	0.5160	0.5156
16	3096K	0.5179	0.5176	0.5173	0.5171	0.5169	0.5166	0.5164	0.5161	0.5158	0.5156	0.5153
17	3106K	0.5179	0.5177	0.5173	0.5172	0.5169	0.5167	0.5165	0.5161	0.5158	0.5157	0.5153
18	3081K	0.5182	0.5180	0.5177	0.5175	0.5172	0.5170	0.5167	0.5164	0.5161	0.5160	0.5156
19	3100K	0.5187	0.5184	0.5180	0.5179	0.5176	0.5173	0.5171	0.5168	0.5164	0.5163	0.5159
20	3082K	0.5176	0.5173	0.5169	0.5168	0.5165	0.5162	0.5159	0.5158	0.5155	0.5153	0.5149
21	2961K	0.5232	0.5230	0.5226	0.5225	0.5222	0.5218	0.5215	0.5214	0.5211	0.5209	0.5206
22	3101K	0.5183	0.5180	0.5176	0.5175	0.5172	0.5168	0.5166	0.5164	0.5161	0.5159	0.5158
23	3099K	0.5167	0.5163	0.5161	0.5159	0.5156	0.5152	0.5150	0.5148	0.5145	0.5144	0.5140
24	3121K	0.5166	0.5164	0.5161	0.5159	0.5157	0.5153	0.5151	0.5149	0.5147	0.5144	0.5140
25	3107K	0.5174	0.5171	0.5168	0.5166	0.5163	0.5159	0.5157	0.5155	0.5152	0.5150	0.5147

**Delta u'v' data for tested units**

$T_s = T_{air} = 105^{\circ}C, I_f = 65mA; T_s \geq 103^{\circ}C$  and  $T_{air} \geq 100^{\circ}C$  in compliance with LM-80-15

	CCT (t=0)	0hrs	1000hrs	2000hrs	3000hrs	4000hrs	5000hrs	6000hrs	7000hrs	8000hrs	9000hrs	10000hrs
1	3114K	0.0000	0.0004	0.0005	0.0009	0.0012	0.0014	0.0016	0.0019	0.0022	0.0026	0.0029
2	3090K	0.0000	0.0004	0.0007	0.0009	0.0012	0.0014	0.0016	0.0020	0.0024	0.0026	0.0030
3	3109K	0.0000	0.0004	0.0006	0.0007	0.0012	0.0014	0.0014	0.0017	0.0023	0.0025	0.0028
4	3118K	0.0000	0.0004	0.0006	0.0009	0.0013	0.0014	0.0015	0.0019	0.0023	0.0026	0.0030
5	2947K	0.0000	0.0005	0.0008	0.0009	0.0013	0.0014	0.0016	0.0020	0.0023	0.0025	0.0029
6	3104K	0.0000	0.0004	0.0007	0.0009	0.0013	0.0015	0.0016	0.0020	0.0023	0.0027	0.0030
7	2920K	0.0000	0.0004	0.0007	0.0009	0.0014	0.0015	0.0016	0.0020	0.0024	0.0027	0.0030
8	3117K	0.0000	0.0006	0.0008	0.0010	0.0014	0.0015	0.0016	0.0021	0.0024	0.0027	0.0030
9	3117K	0.0000	0.0002	0.0005	0.0008	0.0012	0.0014	0.0015	0.0018	0.0023	0.0025	0.0029
10	3126K	0.0000	0.0005	0.0007	0.0009	0.0013	0.0015	0.0016	0.0020	0.0023	0.0026	0.0030
11	3089K	0.0000	0.0006	0.0009	0.0009	0.0014	0.0016	0.0017	0.0022	0.0025	0.0029	0.0032
12	3091K	0.0000	0.0002	0.0006	0.0007	0.0011	0.0013	0.0014	0.0019	0.0022	0.0025	0.0027
13	3127K	0.0000	0.0004	0.0006	0.0009	0.0012	0.0014	0.0016	0.0020	0.0022	0.0027	0.0030
14	3117K	0.0000	0.0004	0.0007	0.0009	0.0012	0.0014	0.0016	0.0020	0.0023	0.0025	0.0029
15	3085K	0.0000	0.0005	0.0008	0.0009	0.0013	0.0014	0.0016	0.0020	0.0023	0.0026	0.0030
16	3096K	0.0000	0.0005	0.0007	0.0009	0.0013	0.0014	0.0016	0.0019	0.0023	0.0026	0.0029
17	3106K	0.0000	0.0004	0.0007	0.0008	0.0013	0.0013	0.0015	0.0019	0.0023	0.0026	0.0029
18	3081K	0.0000	0.0004	0.0005	0.0008	0.0013	0.0013	0.0016	0.0019	0.0023	0.0025	0.0029
19	3100K	0.0000	0.0005	0.0008	0.0009	0.0014	0.0016	0.0017	0.0020	0.0026	0.0028	0.0031
20	3082K	0.0000	0.0004	0.0007	0.0009	0.0013	0.0015	0.0017	0.0019	0.0022	0.0026	0.0030
21	2961K	0.0000	0.0004	0.0006	0.0008	0.0013	0.0016	0.0018	0.0019	0.0023	0.0026	0.0029
22	3101K	0.0000	0.0004	0.0008	0.0009	0.0014	0.0017	0.0018	0.0020	0.0024	0.0027	0.0028
23	3099K	0.0000	0.0005	0.0006	0.0009	0.0013	0.0016	0.0017	0.0020	0.0023	0.0026	0.0030
24	3121K	0.0000	0.0004	0.0006	0.0008	0.0012	0.0014	0.0016	0.0018	0.0021	0.0026	0.0029
25	3107K	0.0000	0.0004	0.0007	0.0009	0.0014	0.0017	0.0018	0.0020	0.0024	0.0027	0.0030

**Forward Voltage [V] data for tested units**

$T_s = T_{air} = 105^{\circ}C, I_f = 65mA; T_s \geq 103^{\circ}C$  and  $T_{air} \geq 100^{\circ}C$  in compliance with LM-80-15

	CCT (t=0)	0hrs	1000hrs	2000hrs	3000hrs	4000hrs	5000hrs	6000hrs	7000hrs	8000hrs	9000hrs	10000hrs
1	3114K	5.603	5.609	5.604	5.613	5.609	5.607	5.607	5.602	5.603	5.601	5.601
2	3090K	5.596	5.579	5.571	5.582	5.576	5.578	5.573	5.575	5.565	5.567	5.568
3	3109K	5.593	5.604	5.590	5.604	5.596	5.836	5.596	5.589	5.863	5.589	5.592
4	3118K	5.581	5.800	5.583	5.604	5.645	5.674	5.583	5.585	5.578	5.578	5.580
5	2947K	5.627	5.585	5.588	5.657	5.586	5.588	5.593	5.583	5.579	5.576	5.582
6	3104K	5.565	5.565	5.559	5.572	5.680	5.577	5.561	5.570	5.555	5.556	5.560
7	2920K	5.614	5.596	5.600	5.613	5.608	5.600	5.596	5.597	5.636	5.592	5.594
8	3117K	5.595	5.783	5.595	5.610	5.771	5.601	5.599	5.612	5.600	5.592	5.603
9	3117K	5.645	5.837	5.587	5.598	5.589	5.587	5.583	5.585	5.580	5.582	5.582
10	3126K	5.557	5.570	5.583	5.565	5.583	5.669	5.558	5.557	5.554	5.551	5.556
11	3089K	5.565	6.797	5.560	5.569	5.563	5.565	5.559	5.566	5.610	5.576	5.560
12	3091K	5.556	5.619	5.928	5.571	5.564	5.566	5.560	5.566	5.576	5.557	5.560
13	3127K	5.587	5.748	5.579	5.840	5.580	5.584	5.580	5.996	5.579	5.572	5.577
14	3117K	5.623	5.599	5.612	5.845	5.615	5.601	5.601	5.605	5.595	5.593	5.599
15	3085K	5.567	5.564	5.562	5.628	5.604	5.569	5.579	5.565	5.582	5.559	5.565
16	3096K	5.592	5.608	5.555	5.571	5.558	5.570	5.579	5.617	5.555	5.552	5.555
17	3106K	5.580	5.554	5.550	5.564	5.553	5.562	5.552	5.558	5.554	5.546	5.551
18	3081K	5.592	5.781	5.595	5.611	5.594	5.610	5.593	5.648	5.592	5.590	5.596
19	3100K	5.842	5.593	5.617	5.658	5.600	5.597	5.593	5.593	5.586	5.587	5.593
20	3082K	5.598	5.620	5.714	5.612	5.611	5.613	5.602	5.600	5.598	5.598	5.599
21	2961K	5.619	5.602	5.605	5.617	5.603	5.608	5.624	5.605	5.603	5.597	5.602
22	3101K	5.623	5.602	5.597	5.607	5.599	5.602	5.598	5.596	5.601	5.591	5.595
23	3099K	5.574	5.592	5.581	5.592	5.580	5.578	5.576	5.577	5.578	5.573	5.577
24	3121K	5.575	5.626	5.580	5.578	5.572	5.571	5.568	5.571	5.566	5.563	5.570
25	3107K	5.577	5.671	5.707	5.722	5.589	5.587	5.582	5.624	5.585	5.580	5.584

**Luminous Flux [lm] data for tested units**

$T_s = T_{air} = 85^{\circ}\text{C}$ ;  $I_f = 100\text{mA}$ ;  $T_s \geq 83^{\circ}\text{C}$  and  $T_{air} \geq 80^{\circ}\text{C}$  in compliance with LM-80-15

	CCT (t=0)	0hrs	1000hrs	2000hrs	3000hrs	4000hrs	5000hrs	6000hrs	7000hrs	8000hrs	9000hrs	10000hrs
1	3118K	108.400	108.700	108.600	108.300	108.200	108.000	107.700	107.400	107.200	107.000	106.800
2	3111K	109.300	109.100	108.900	108.800	108.700	108.400	108.200	108.000	107.800	107.600	107.200
3	3129K	107.000	106.900	106.700	106.600	106.500	106.300	105.900	105.700	105.600	105.300	105.000
4	3129K	108.700	108.500	108.300	108.100	107.900	107.600	107.400	107.300	107.100	107.000	106.700
5	3134K	106.900	106.800	106.700	106.600	106.400	106.100	105.900	105.700	105.500	105.200	104.900
6	3131K	106.400	106.000	105.800	105.700	105.600	105.300	105.200	104.800	104.600	104.300	103.900
7	3109K	108.100	107.900	107.700	107.600	107.400	107.200	106.900	106.600	106.300	106.100	105.800
8	3124K	108.700	108.600	108.400	108.300	108.100	107.900	107.800	107.600	107.500	107.100	106.900
9	3130K	107.500	107.600	107.400	107.200	107.000	106.800	106.600	106.400	106.200	106.000	105.800
10	3131K	107.900	107.800	107.700	107.400	107.200	106.900	106.700	106.500	106.200	105.900	105.600
11	3078K	105.900	106.100	106.000	105.800	105.700	105.500	105.200	105.000	104.800	104.600	104.300
12	3086K	109.000	108.800	108.500	108.300	108.100	107.900	107.600	107.200	106.900	106.700	106.300
13	3162K	109.700	109.300	109.100	109.000	108.800	108.600	108.300	107.900	107.700	107.500	107.200
14	3123K	107.400	107.300	107.000	106.900	106.800	106.600	106.300	106.000	105.600	105.500	105.400
15	3150K	108.400	108.100	108.000	107.700	107.500	107.300	107.000	106.700	106.300	106.100	105.900
16	3148K	108.400	108.000	107.700	107.600	107.400	107.100	106.900	106.800	106.500	106.300	106.000
17	3128K	107.700	107.400	107.200	107.000	106.900	106.700	106.400	106.200	106.100	105.900	105.700
18	3103K	107.700	107.600	107.300	107.100	107.000	106.700	106.500	106.200	105.800	105.600	105.300
19	3132K	109.300	109.000	108.800	108.700	108.500	108.400	108.200	108.000	107.700	107.400	107.000
20	3099K	107.000	106.700	106.600	106.400	106.300	106.000	105.600	105.300	105.100	104.900	104.600
21	3114K	106.600	106.200	106.100	105.800	105.600	105.400	105.100	105.000	104.700	104.300	104.200
22	3088K	107.900	107.800	107.700	107.500	107.300	107.000	106.700	106.400	106.200	105.900	105.500
23	3141K	108.400	108.500	108.200	108.100	107.900	107.600	107.500	107.300	107.000	106.800	106.400
24	3116K	108.400	108.300	108.100	107.900	107.800	107.500	107.300	107.000	106.800	106.500	106.200
25	3121K	107.200	107.000	106.700	106.600	106.400	106.300	106.100	105.900	105.600	105.300	104.900

**Normalized Luminous Flux data for tested units**

$T_s = T_{air} = 85^{\circ}\text{C}$ ;  $I_f = 100\text{mA}$ ;  $T_s \geq 83^{\circ}\text{C}$  and  $T_{air} \geq 80^{\circ}\text{C}$  in compliance with LM-80-15

	CCT (t=0)	0hrs	1000hrs	2000hrs	3000hrs	4000hrs	5000hrs	6000hrs	7000hrs	8000hrs	9000hrs	10000hrs
1	3118K	1.0000	1.0028	1.0018	0.9991	0.9982	0.9963	0.9935	0.9908	0.9889	0.9871	0.9852
2	3111K	1.0000	0.9982	0.9963	0.9954	0.9945	0.9918	0.9899	0.9881	0.9863	0.9844	0.9808
3	3129K	1.0000	0.9991	0.9972	0.9963	0.9953	0.9935	0.9897	0.9879	0.9869	0.9841	0.9813
4	3129K	1.0000	0.9982	0.9963	0.9945	0.9926	0.9899	0.9880	0.9871	0.9853	0.9844	0.9816
5	3134K	1.0000	0.9991	0.9981	0.9972	0.9953	0.9925	0.9906	0.9888	0.9869	0.9841	0.9813
6	3131K	1.0000	0.9962	0.9944	0.9934	0.9925	0.9897	0.9887	0.9850	0.9831	0.9803	0.9765
7	3109K	1.0000	0.9981	0.9963	0.9954	0.9935	0.9917	0.9889	0.9861	0.9833	0.9815	0.9787
8	3124K	1.0000	0.9991	0.9972	0.9963	0.9945	0.9926	0.9917	0.9899	0.9890	0.9853	0.9834
9	3130K	1.0000	1.0009	0.9991	0.9972	0.9953	0.9935	0.9916	0.9898	0.9879	0.9860	0.9842
10	3131K	1.0000	0.9991	0.9981	0.9954	0.9935	0.9907	0.9889	0.9870	0.9842	0.9815	0.9787
11	3078K	1.0000	1.0019	1.0009	0.9991	0.9981	0.9962	0.9934	0.9915	0.9896	0.9877	0.9849
12	3086K	1.0000	0.9982	0.9954	0.9936	0.9917	0.9899	0.9872	0.9835	0.9807	0.9789	0.9752
13	3162K	1.0000	0.9964	0.9945	0.9936	0.9918	0.9900	0.9872	0.9836	0.9818	0.9799	0.9772
14	3123K	1.0000	0.9991	0.9963	0.9953	0.9944	0.9926	0.9898	0.9870	0.9832	0.9823	0.9814
15	3150K	1.0000	0.9972	0.9963	0.9935	0.9917	0.9899	0.9871	0.9843	0.9806	0.9788	0.9769
16	3148K	1.0000	0.9963	0.9935	0.9926	0.9908	0.9880	0.9862	0.9852	0.9825	0.9806	0.9779
17	3128K	1.0000	0.9972	0.9954	0.9935	0.9926	0.9907	0.9879	0.9861	0.9851	0.9833	0.9814
18	3103K	1.0000	0.9991	0.9963	0.9944	0.9935	0.9907	0.9889	0.9861	0.9824	0.9805	0.9777
19	3132K	1.0000	0.9973	0.9954	0.9945	0.9927	0.9918	0.9899	0.9881	0.9854	0.9826	0.9790
20	3099K	1.0000	0.9972	0.9963	0.9944	0.9935	0.9907	0.9869	0.9841	0.9822	0.9804	0.9776
21	3114K	1.0000	0.9962	0.9953	0.9925	0.9906	0.9887	0.9859	0.9850	0.9822	0.9784	0.9775
22	3088K	1.0000	0.9991	0.9981	0.9963	0.9944	0.9917	0.9889	0.9861	0.9842	0.9815	0.9778
23	3141K	1.0000	1.0009	0.9982	0.9972	0.9954	0.9926	0.9917	0.9899	0.9871	0.9852	0.9815
24	3116K	1.0000	0.9991	0.9972	0.9954	0.9945	0.9917	0.9899	0.9871	0.9852	0.9825	0.9797
25	3121K	1.0000	0.9981	0.9953	0.9944	0.9925	0.9916	0.9897	0.9879	0.9851	0.9823	0.9785

**CIE 1976 u' data for tested units**

$T_s = T_{air} = 85^\circ\text{C}$ ,  $I_f = 100\text{mA}$ ;  $T_s \geq 83^\circ\text{C}$  and  $T_{air} \geq 80^\circ\text{C}$  in compliance with LM-80-15

	CCT (t=0)	0hrs	1000hrs	2000hrs	3000hrs	4000hrs	5000hrs	6000hrs	7000hrs	8000hrs	9000hrs	10000hrs
1	3118K	0.2467	0.2463	0.2462	0.2463	0.2458	0.2459	0.2460	0.2459	0.2456	0.2453	0.2452
2	3111K	0.2468	0.2465	0.2466	0.2467	0.2461	0.2462	0.2463	0.2462	0.2459	0.2456	0.2455
3	3129K	0.2464	0.2461	0.2462	0.2462	0.2457	0.2458	0.2460	0.2458	0.2456	0.2453	0.2451
4	3129K	0.2463	0.2459	0.2460	0.2460	0.2454	0.2456	0.2457	0.2456	0.2453	0.2449	0.2450
5	3134K	0.2461	0.2458	0.2459	0.2460	0.2454	0.2455	0.2457	0.2455	0.2453	0.2449	0.2449
6	3131K	0.2467	0.2461	0.2463	0.2464	0.2458	0.2459	0.2461	0.2459	0.2457	0.2453	0.2453
7	3109K	0.2469	0.2465	0.2465	0.2468	0.2461	0.2463	0.2464	0.2461	0.2459	0.2455	0.2455
8	3124K	0.2463	0.2461	0.2460	0.2462	0.2456	0.2457	0.2458	0.2455	0.2453	0.2449	0.2450
9	3130K	0.2467	0.2463	0.2464	0.2466	0.2460	0.2462	0.2463	0.2461	0.2459	0.2455	0.2455
10	3131K	0.2460	0.2457	0.2457	0.2459	0.2454	0.2455	0.2456	0.2454	0.2452	0.2449	0.2448
11	3078K	0.2482	0.2474	0.2474	0.2476	0.2471	0.2472	0.2472	0.2471	0.2469	0.2465	0.2465
12	3086K	0.2480	0.2475	0.2476	0.2478	0.2473	0.2474	0.2473	0.2473	0.2470	0.2466	0.2466
13	3162K	0.2447	0.2444	0.2445	0.2445	0.2441	0.2441	0.2442	0.2440	0.2454	0.2433	0.2433
14	3123K	0.2465	0.2464	0.2465	0.2465	0.2460	0.2462	0.2462	0.2460	0.2459	0.2454	0.2454
15	3150K	0.2454	0.2452	0.2452	0.2453	0.2448	0.2449	0.2449	0.2447	0.2446	0.2442	0.2441
16	3148K	0.2453	0.2449	0.2450	0.2451	0.2445	0.2447	0.2449	0.2445	0.2443	0.2440	0.2439
17	3128K	0.2461	0.2458	0.2459	0.2459	0.2455	0.2456	0.2459	0.2454	0.2453	0.2449	0.2449
18	3103K	0.2471	0.2469	0.2470	0.2470	0.2465	0.2466	0.2468	0.2465	0.2463	0.2459	0.2459
19	3132K	0.2460	0.2456	0.2457	0.2457	0.2453	0.2453	0.2456	0.2452	0.2451	0.2447	0.2446
20	3099K	0.2476	0.2472	0.2473	0.2473	0.2469	0.2470	0.2472	0.2466	0.2466	0.2462	0.2462
21	3114K	0.2469	0.2465	0.2466	0.2467	0.2461	0.2463	0.2465	0.2461	0.2460	0.2455	0.2455
22	3088K	0.2481	0.2479	0.2479	0.2480	0.2474	0.2476	0.2479	0.2474	0.2473	0.2469	0.2470
23	3141K	0.2456	0.2453	0.2453	0.2454	0.2449	0.2451	0.2453	0.2449	0.2448	0.2444	0.2444
24	3116K	0.2468	0.2465	0.2465	0.2465	0.2461	0.2462	0.2464	0.2461	0.2459	0.2455	0.2454
25	3121K	0.2467	0.2464	0.2465	0.2465	0.2460	0.2461	0.2464	0.2459	0.2457	0.2454	0.2453

**CIE 1976 v' data for tested units**

$T_s = T_{air} = 85^\circ\text{C}$ ,  $I_f = 100\text{mA}$ ;  $T_s \geq 83^\circ\text{C}$  and  $T_{air} \geq 80^\circ\text{C}$  in compliance with LM-80-15

	CCT (t=0)	0hrs	1000hrs	2000hrs	3000hrs	4000hrs	5000hrs	6000hrs	7000hrs	8000hrs	9000hrs	10000hrs
1	3118K	0.5184	0.5177	0.5174	0.5171	0.5169	0.5166	0.5163	0.5160	0.5158	0.5155	0.5152
2	3111K	0.5191	0.5188	0.5185	0.5182	0.5181	0.5178	0.5174	0.5172	0.5170	0.5168	0.5165
3	3129K	0.5180	0.5177	0.5174	0.5171	0.5170	0.5166	0.5162	0.5161	0.5159	0.5156	0.5153
4	3129K	0.5184	0.5180	0.5177	0.5175	0.5173	0.5170	0.5165	0.5164	0.5162	0.5159	0.5156
5	3134K	0.5184	0.5181	0.5179	0.5176	0.5175	0.5171	0.5167	0.5165	0.5163	0.5161	0.5158
6	3131K	0.5167	0.5162	0.5159	0.5156	0.5154	0.5152	0.5148	0.5146	0.5144	0.5141	0.5138
7	3109K	0.5189	0.5185	0.5183	0.5179	0.5178	0.5175	0.5170	0.5169	0.5166	0.5164	0.5160
8	3124K	0.5190	0.5187	0.5185	0.5181	0.5180	0.5177	0.5172	0.5170	0.5168	0.5166	0.5162
9	3130K	0.5168	0.5165	0.5163	0.5160	0.5158	0.5156	0.5151	0.5150	0.5147	0.5145	0.5142
10	3131K	0.5192	0.5190	0.5188	0.5185	0.5184	0.5181	0.5176	0.5174	0.5172	0.5170	0.5166
11	3078K	0.5185	0.5181	0.5179	0.5175	0.5175	0.5172	0.5166	0.5164	0.5163	0.5160	0.5157
12	3086K	0.5182	0.5178	0.5176	0.5173	0.5172	0.5169	0.5164	0.5162	0.5159	0.5158	0.5154
13	3162K	0.5196	0.5193	0.5191	0.5188	0.5187	0.5183	0.5178	0.5177	0.5176	0.5172	0.5168
14	3123K	0.5185	0.5183	0.5179	0.5177	0.5176	0.5173	0.5168	0.5166	0.5165	0.5162	0.5159
15	3150K	0.5188	0.5185	0.5182	0.5179	0.5179	0.5176	0.5170	0.5169	0.5168	0.5164	0.5160
16	3148K	0.5194	0.5190	0.5188	0.5186	0.5185	0.5181	0.5182	0.5174	0.5173	0.5169	0.5166
17	3128K	0.5192	0.5188	0.5185	0.5182	0.5182	0.5179	0.5179	0.5172	0.5170	0.5167	0.5164
18	3103K	0.5190	0.5186	0.5184	0.5181	0.5180	0.5177	0.5176	0.5170	0.5168	0.5165	0.5162
19	3132K	0.5190	0.5186	0.5183	0.5180	0.5180	0.5177	0.5176	0.5169	0.5168	0.5165	0.5161
20	3099K	0.5178	0.5174	0.5171	0.5169	0.5168	0.5165	0.5164	0.5157	0.5155	0.5152	0.5149
21	3114K	0.5182	0.5178	0.5175	0.5173	0.5172	0.5169	0.5168	0.5163	0.5160	0.5157	0.5154
22	3088K	0.5175	0.5172	0.5169	0.5166	0.5165	0.5163	0.5162	0.5156	0.5154	0.5151	0.5148
23	3141K	0.5192	0.5189	0.5185	0.5183	0.5183	0.5180	0.5179	0.5173	0.5171	0.5168	0.5165
24	3116K	0.5183	0.5180	0.5177	0.5175	0.5174	0.5171	0.5170	0.5165	0.5162	0.5159	0.5156
25	3121K	0.5180	0.5176	0.5174	0.5171	0.5170	0.5168	0.5167	0.5160	0.5158	0.5155	0.5152

**Delta u'v' data for tested units**

**T<sub>s</sub> = T<sub>air</sub> = 85°C, I<sub>f</sub> = 100mA; T<sub>s</sub> ≥ 83°C and T<sub>air</sub> ≥ 80°C in compliance with LM-80-15**

	CCT (t=0)	0hrs	1000hrs	2000hrs	3000hrs	4000hrs	5000hrs	6000hrs	7000hrs	8000hrs	9000hrs	10000hrs
1	3118K	0.0000	0.0008	0.0011	0.0014	0.0017	0.0020	0.0022	0.0025	0.0028	0.0032	0.0035
2	3111K	0.0000	0.0004	0.0006	0.0009	0.0012	0.0014	0.0018	0.0020	0.0023	0.0026	0.0029
3	3129K	0.0000	0.0004	0.0006	0.0009	0.0012	0.0015	0.0018	0.0020	0.0022	0.0026	0.0030
4	3129K	0.0000	0.0006	0.0008	0.0009	0.0014	0.0016	0.0020	0.0021	0.0024	0.0029	0.0031
5	3134K	0.0000	0.0004	0.0005	0.0008	0.0011	0.0014	0.0017	0.0020	0.0022	0.0026	0.0029
6	3131K	0.0000	0.0008	0.0009	0.0011	0.0016	0.0017	0.0020	0.0022	0.0025	0.0030	0.0032
7	3109K	0.0000	0.0006	0.0007	0.0010	0.0014	0.0015	0.0020	0.0022	0.0025	0.0029	0.0032
8	3124K	0.0000	0.0004	0.0006	0.0009	0.0012	0.0014	0.0019	0.0022	0.0024	0.0028	0.0031
9	3130K	0.0000	0.0005	0.0006	0.0008	0.0012	0.0013	0.0017	0.0019	0.0022	0.0026	0.0029
10	3131K	0.0000	0.0004	0.0005	0.0007	0.0010	0.0012	0.0016	0.0019	0.0022	0.0025	0.0029
11	3078K	0.0000	0.0009	0.0010	0.0012	0.0015	0.0016	0.0021	0.0024	0.0026	0.0030	0.0033
12	3086K	0.0000	0.0006	0.0007	0.0009	0.0012	0.0014	0.0019	0.0021	0.0025	0.0028	0.0031
13	3162K	0.0000	0.0004	0.0005	0.0008	0.0011	0.0014	0.0019	0.0020	0.0021	0.0028	0.0031
14	3123K	0.0000	0.0002	0.0006	0.0008	0.0010	0.0012	0.0017	0.0020	0.0021	0.0025	0.0028
15	3150K	0.0000	0.0004	0.0006	0.0009	0.0011	0.0013	0.0019	0.0020	0.0022	0.0027	0.0031
16	3148K	0.0000	0.0006	0.0007	0.0008	0.0012	0.0014	0.0013	0.0022	0.0023	0.0028	0.0031
17	3128K	0.0000	0.0005	0.0007	0.0010	0.0012	0.0014	0.0013	0.0021	0.0023	0.0028	0.0030
18	3103K	0.0000	0.0004	0.0006	0.0009	0.0012	0.0014	0.0014	0.0021	0.0023	0.0028	0.0030
19	3132K	0.0000	0.0006	0.0008	0.0010	0.0012	0.0015	0.0015	0.0022	0.0024	0.0028	0.0032
20	3099K	0.0000	0.0006	0.0008	0.0009	0.0012	0.0014	0.0015	0.0023	0.0025	0.0030	0.0032
21	3114K	0.0000	0.0006	0.0008	0.0009	0.0013	0.0014	0.0015	0.0021	0.0024	0.0029	0.0031
22	3088K	0.0000	0.0004	0.0006	0.0009	0.0012	0.0013	0.0013	0.0020	0.0022	0.0027	0.0029
23	3141K	0.0000	0.0004	0.0008	0.0009	0.0011	0.0013	0.0013	0.0020	0.0022	0.0027	0.0030
24	3116K	0.0000	0.0004	0.0007	0.0009	0.0011	0.0013	0.0014	0.0019	0.0023	0.0027	0.0030
25	3121K	0.0000	0.0005	0.0006	0.0009	0.0012	0.0013	0.0013	0.0022	0.0024	0.0028	0.0031

**Forward Voltage [V] data for tested units**

**T<sub>s</sub> = T<sub>air</sub> = 85°C, I<sub>f</sub> = 100mA; T<sub>s</sub> ≥ 83°C and T<sub>air</sub> ≥ 80°C in compliance with LM-80-15**

	CCT (t=0)	0hrs	1000hrs	2000hrs	3000hrs	4000hrs	5000hrs	6000hrs	7000hrs	8000hrs	9000hrs	10000hrs
1	3118K	5.742	6.466	5.754	5.757	5.751	5.755	5.745	5.742	5.744	5.745	5.740
2	3111K	5.765	5.773	5.800	5.782	5.767	5.771	5.771	5.765	5.766	5.784	5.767
3	3129K	5.721	5.720	5.951	5.737	5.730	5.723	5.720	5.717	5.715	5.723	5.713
4	3129K	5.815	5.793	5.796	5.900	5.810	5.831	5.790	5.785	5.803	5.789	5.785
5	3134K	5.763	5.766	5.764	5.781	5.868	5.778	5.776	5.998	5.758	5.852	5.760
6	3131K	5.786	6.164	5.922	5.790	5.746	5.747	5.744	5.740	5.754	5.738	5.741
7	3109K	5.775	5.782	5.782	5.811	5.782	6.069	5.787	5.777	5.776	5.781	5.778
8	3124K	5.771	5.808	5.825	5.819	5.829	5.778	5.792	5.770	5.771	5.774	5.770
9	3130K	5.732	5.741	6.137	5.746	5.738	5.739	5.739	5.733	5.735	5.735	5.732
10	3131K	5.952	5.810	5.820	5.798	5.882	5.783	5.781	5.774	5.776	5.779	5.775
11	3078K	5.827	5.773	5.770	5.781	5.895	5.767	5.765	5.760	5.760	5.762	5.759
12	3086K	5.722	5.744	5.729	5.763	5.728	5.732	5.727	5.721	5.719	5.725	5.723
13	3162K	5.786	5.822	5.788	5.801	5.809	5.788	5.788	5.779	5.707	5.784	5.784
14	3123K	5.721	5.722	5.727	5.736	5.729	5.728	5.934	5.722	5.724	5.722	5.722
15	3150K	5.751	5.752	5.749	5.761	5.755	5.760	5.869	5.748	5.746	5.748	5.749
16	3148K	5.734	5.889	5.741	5.755	5.744	5.743	5.741	5.740	5.735	5.740	5.752
17	3128K	5.755	5.760	5.766	5.772	5.761	5.751	5.751	5.752	5.745	5.750	5.750
18	3103K	5.720	5.956	5.726	5.755	5.728	5.732	5.726	5.730	5.722	5.724	5.720
19	3132K	5.776	5.888	5.745	5.755	5.910	5.758	5.742	5.742	5.741	5.742	5.738
20	3099K	5.821	5.792	5.731	5.744	5.731	5.735	5.730	5.732	5.726	5.727	5.728
21	3114K	5.772	5.730	5.709	5.726	5.708	5.718	5.711	5.709	5.720	5.705	5.706
22	3088K	5.869	5.753	5.735	5.758	5.837	5.743	5.744	5.744	5.734	5.734	5.735
23	3141K	5.736	5.807	5.740	5.752	5.741	5.748	5.741	5.740	5.739	5.741	5.737
24	3116K	5.774	5.798	5.775	5.753	5.745	5.760	5.744	5.739	5.733	5.737	5.738
25	3121K	5.732	5.737	5.732	5.748	5.733	5.738	5.738	5.749	5.728	5.732	5.733

**Luminous Flux [lm] data for tested units**

$T_s = T_{air} = 105^{\circ}C, I_f = 120mA; T_s \geq 103^{\circ}C$  and  $T_{air} \geq 100^{\circ}C$  in compliance with LM-80-15

	CCT (t=0)	0hrs	1000hrs	2000hrs	3000hrs	4000hrs	5000hrs	6000hrs	7000hrs	8000hrs	9000hrs	10000hrs
1	3070K	125.800	125.500	125.200	124.900	124.500	124.300	124.100	123.800	123.600	123.200	123.100
2	3078K	125.600	125.400	125.300	125.100	124.900	124.700	124.400	124.200	124.100	123.800	123.500
3	3133K	127.500	127.100	126.800	126.500	126.100	125.700	125.600	125.300	125.000	124.800	124.300
4	3136K	125.300	125.000	124.800	124.600	124.300	123.900	123.700	123.300	123.000	122.900	122.600
5	2980K	127.400	127.500	127.100	127.000	126.500	126.400	126.000	125.600	125.500	125.100	125.000
6	3140K	124.900	125.100	124.700	124.600	124.300	124.100	123.900	123.700	123.500	123.100	122.600
7	3130K	126.700	126.800	126.500	126.200	126.000	125.600	125.200	125.000	124.500	124.200	123.900
8	3094K	127.200	127.000	126.500	126.400	126.100	125.800	125.500	125.100	124.800	124.300	123.900
9	3000K	127.200	127.100	126.700	126.500	126.300	125.800	125.400	125.100	124.500	124.100	123.700
10	3139K	127.100	126.800	126.500	126.400	126.100	125.700	125.400	125.000	124.600	124.400	124.200
11	3141K	128.300	128.100	127.800	127.400	127.300	127.000	126.600	126.300	126.100	125.700	125.300
12	3146K	128.400	127.900	127.500	127.200	127.000	126.800	126.400	126.300	125.800	125.500	125.200
13	3144K	120.200	120.000	119.600	119.400	119.100	118.900	118.800	118.600	118.300	117.900	117.500
14	3150K	125.800	125.900	125.400	125.100	124.900	124.600	124.200	123.800	123.500	123.000	122.800
15	3142K	127.800	127.600	127.200	127.000	126.700	126.400	125.900	125.500	125.100	124.800	124.700
16	3133K	126.900	126.800	126.400	126.100	125.800	125.500	125.200	124.900	124.700	124.400	124.000
17	3109K	126.800	126.900	126.500	126.100	125.800	125.600	125.400	125.300	125.200	124.900	124.600
18	3136K	124.700	124.400	124.100	124.000	123.600	123.300	123.000	122.700	122.500	122.300	122.000
19	3149K	127.100	126.600	126.200	126.100	125.900	125.500	125.000	124.700	124.300	123.800	123.600
20	3143K	125.900	125.600	125.400	125.200	124.700	124.400	124.100	123.700	123.400	122.900	122.500
21	3121K	122.500	122.600	122.300	122.000	121.800	121.400	121.100	121.000	120.700	120.400	120.100
22	3096K	124.600	124.000	123.800	123.600	123.400	123.000	122.600	122.500	122.200	121.600	121.200
23	3134K	127.000	126.800	126.600	126.400	125.900	125.600	125.200	124.900	124.500	124.100	123.600
24	3142K	126.000	125.900	125.600	125.300	125.000	124.800	124.400	124.000	123.800	123.500	123.000
25	3156K	127.700	127.400	127.300	127.100	126.800	126.500	126.300	125.900	125.500	125.300	124.900

**Normalized Luminous Flux data for tested units**

$T_s = T_{air} = 105^{\circ}C, I_f = 120mA; T_s \geq 103^{\circ}C$  and  $T_{air} \geq 100^{\circ}C$  in compliance with LM-80-15

	CCT (t=0)	0hrs	1000hrs	2000hrs	3000hrs	4000hrs	5000hrs	6000hrs	7000hrs	8000hrs	9000hrs	10000hrs
1	3070K	1.0000	0.9976	0.9952	0.9928	0.9897	0.9881	0.9865	0.9841	0.9825	0.9793	0.9785
2	3078K	1.0000	0.9984	0.9976	0.9960	0.9944	0.9928	0.9904	0.9889	0.9881	0.9857	0.9833
3	3133K	1.0000	0.9969	0.9945	0.9922	0.9890	0.9859	0.9851	0.9827	0.9804	0.9788	0.9749
4	3136K	1.0000	0.9976	0.9960	0.9944	0.9920	0.9888	0.9872	0.9840	0.9816	0.9808	0.9785
5	2980K	1.0000	1.0008	0.9976	0.9969	0.9929	0.9922	0.9890	0.9859	0.9851	0.9819	0.9812
6	3140K	1.0000	1.0016	0.9984	0.9976	0.9952	0.9936	0.9920	0.9904	0.9888	0.9856	0.9816
7	3130K	1.0000	1.0008	0.9984	0.9961	0.9945	0.9913	0.9882	0.9866	0.9826	0.9803	0.9779
8	3094K	1.0000	0.9984	0.9945	0.9937	0.9914	0.9890	0.9866	0.9835	0.9811	0.9772	0.9741
9	3000K	1.0000	0.9992	0.9961	0.9945	0.9929	0.9890	0.9858	0.9835	0.9788	0.9756	0.9725
10	3139K	1.0000	0.9976	0.9953	0.9945	0.9921	0.9890	0.9866	0.9835	0.9803	0.9788	0.9772
11	3141K	1.0000	0.9984	0.9961	0.9930	0.9922	0.9899	0.9867	0.9844	0.9829	0.9797	0.9766
12	3146K	1.0000	0.9961	0.9930	0.9907	0.9891	0.9875	0.9844	0.9836	0.9798	0.9774	0.9751
13	3144K	1.0000	0.9983	0.9950	0.9933	0.9908	0.9892	0.9884	0.9867	0.9842	0.9809	0.9775
14	3150K	1.0000	1.0008	0.9968	0.9944	0.9928	0.9905	0.9873	0.9841	0.9817	0.9777	0.9762
15	3142K	1.0000	0.9984	0.9953	0.9937	0.9914	0.9890	0.9851	0.9820	0.9789	0.9765	0.9757
16	3133K	1.0000	0.9992	0.9961	0.9929	0.9913	0.9890	0.9866	0.9842	0.9827	0.9803	0.9771
17	3109K	1.0000	1.0008	0.9976	0.9945	0.9921	0.9905	0.9890	0.9882	0.9874	0.9850	0.9826
18	3136K	1.0000	0.9976	0.9952	0.9944	0.9912	0.9888	0.9864	0.9840	0.9824	0.9808	0.9783
19	3149K	1.0000	0.9961	0.9929	0.9921	0.9906	0.9874	0.9835	0.9811	0.9780	0.9740	0.9725
20	3143K	1.0000	0.9976	0.9960	0.9944	0.9905	0.9881	0.9857	0.9825	0.9801	0.9762	0.9730
21	3121K	1.0000	1.0008	0.9984	0.9959	0.9943	0.9910	0.9886	0.9878	0.9853	0.9829	0.9804
22	3096K	1.0000	0.9952	0.9936	0.9920	0.9904	0.9872	0.9839	0.9831	0.9807	0.9759	0.9727
23	3134K	1.0000	0.9984	0.9969	0.9953	0.9913	0.9890	0.9858	0.9835	0.9803	0.9772	0.9732
24	3142K	1.0000	0.9992	0.9968	0.9944	0.9921	0.9905	0.9873	0.9841	0.9825	0.9802	0.9762
25	3156K	1.0000	0.9977	0.9969	0.9953	0.9930	0.9906	0.9890	0.9859	0.9828	0.9812	0.9781

**CIE 1976 u' data for tested units**

$T_s = T_{air} = 105^\circ\text{C}$ ,  $I_f = 120\text{mA}$ ;  $T_s \geq 103^\circ\text{C}$  and  $T_{air} \geq 100^\circ\text{C}$  in compliance with LM-80-15

	CCT (t=0)	0hrs	1000hrs	2000hrs	3000hrs	4000hrs	5000hrs	6000hrs	7000hrs	8000hrs	9000hrs	10000hrs
1	3070K	0.2487	0.2484	0.2486	0.2485	0.2480	0.2481	0.2485	0.2483	0.2479	0.2476	0.2475
2	3078K	0.2478	0.2469	0.2472	0.2468	0.2462	0.2463	0.2468	0.2464	0.2460	0.2457	0.2456
3	3133K	0.2459	0.2456	0.2458	0.2456	0.2452	0.2452	0.2458	0.2454	0.2450	0.2447	0.2446
4	3136K	0.2458	0.2453	0.2455	0.2454	0.2449	0.2450	0.2455	0.2451	0.2448	0.2445	0.2443
5	2980K	0.2504	0.2506	0.2504	0.2507	0.2502	0.2502	0.2503	0.2499	0.2501	0.2495	0.2497
6	3140K	0.2457	0.2452	0.2453	0.2453	0.2448	0.2449	0.2453	0.2449	0.2448	0.2444	0.2445
7	3130K	0.2462	0.2460	0.2461	0.2460	0.2456	0.2456	0.2459	0.2456	0.2453	0.2450	0.2450
8	3094K	0.2476	0.2473	0.2474	0.2473	0.2469	0.2470	0.2473	0.2470	0.2468	0.2464	0.2464
9	3000K	0.2495	0.2493	0.2494	0.2494	0.2489	0.2489	0.2493	0.2491	0.2488	0.2484	0.2484
10	3139K	0.2457	0.2456	0.2457	0.2456	0.2452	0.2453	0.2456	0.2454	0.2450	0.2447	0.2447
11	3141K	0.2458	0.2455	0.2457	0.2456	0.2452	0.2452	0.2455	0.2452	0.2450	0.2447	0.2447
12	3146K	0.2454	0.2452	0.2453	0.2453	0.2447	0.2448	0.2451	0.2449	0.2446	0.2443	0.2443
13	3144K	0.2452	0.2448	0.2450	0.2449	0.2445	0.2446	0.2449	0.2447	0.2445	0.2440	0.2441
14	3150K	0.2458	0.2457	0.2459	0.2457	0.2453	0.2454	0.2456	0.2453	0.2452	0.2447	0.2448
15	3142K	0.2449	0.2446	0.2448	0.2446	0.2443	0.2443	0.2446	0.2443	0.2441	0.2436	0.2438
16	3133K	0.2462	0.2459	0.2461	0.2460	0.2456	0.2457	0.2460	0.2457	0.2454	0.2450	0.2450
17	3109K	0.2466	0.2460	0.2462	0.2461	0.2455	0.2456	0.2459	0.2456	0.2454	0.2451	0.2451
18	3136K	0.2461	0.2457	0.2460	0.2458	0.2455	0.2455	0.2459	0.2455	0.2451	0.2448	0.2449
19	3149K	0.2453	0.2450	0.2452	0.2450	0.2446	0.2446	0.2449	0.2446	0.2444	0.2441	0.2440
20	3143K	0.2458	0.2456	0.2458	0.2457	0.2452	0.2453	0.2456	0.2453	0.2451	0.2447	0.2446
21	3121K	0.2464	0.2460	0.2463	0.2462	0.2458	0.2458	0.2461	0.2459	0.2456	0.2452	0.2452
22	3096K	0.2475	0.2472	0.2474	0.2471	0.2467	0.2467	0.2471	0.2468	0.2466	0.2462	0.2462
23	3134K	0.2456	0.2451	0.2454	0.2452	0.2448	0.2448	0.2452	0.2449	0.2446	0.2443	0.2444
24	3142K	0.2453	0.2450	0.2452	0.2450	0.2446	0.2446	0.2450	0.2447	0.2445	0.2443	0.2442
25	3156K	0.2455	0.2452	0.2453	0.2452	0.2448	0.2449	0.2452	0.2449	0.2447	0.2443	0.2443

**CIE 1976 v' data for tested units**

$T_s = T_{air} = 105^\circ\text{C}$ ,  $I_f = 120\text{mA}$ ;  $T_s \geq 103^\circ\text{C}$  and  $T_{air} \geq 100^\circ\text{C}$  in compliance with LM-80-15

	CCT (t=0)	0hrs	1000hrs	2000hrs	3000hrs	4000hrs	5000hrs	6000hrs	7000hrs	8000hrs	9000hrs	10000hrs
1	3070K	0.5179	0.5173	0.5169	0.5167	0.5167	0.5163	0.5160	0.5159	0.5156	0.5153	0.5149
2	3078K	0.5201	0.5192	0.5188	0.5184	0.5183	0.5179	0.5175	0.5173	0.5171	0.5169	0.5165
3	3133K	0.5192	0.5187	0.5183	0.5180	0.5180	0.5177	0.5174	0.5171	0.5169	0.5167	0.5164
4	3136K	0.5192	0.5186	0.5182	0.5180	0.5180	0.5176	0.5173	0.5170	0.5168	0.5167	0.5163
5	2980K	0.5252	0.5251	0.5245	0.5244	0.5244	0.5240	0.5235	0.5232	0.5232	0.5230	0.5229
6	3140K	0.5190	0.5181	0.5178	0.5175	0.5175	0.5170	0.5167	0.5165	0.5163	0.5161	0.5160
7	3130K	0.5186	0.5181	0.5178	0.5175	0.5175	0.5171	0.5167	0.5165	0.5161	0.5159	0.5158
8	3094K	0.5185	0.5180	0.5176	0.5173	0.5173	0.5169	0.5166	0.5164	0.5162	0.5159	0.5157
9	3000K	0.5255	0.5250	0.5247	0.5244	0.5245	0.5240	0.5236	0.5235	0.5233	0.5232	0.5229
10	3139K	0.5191	0.5187	0.5185	0.5181	0.5181	0.5176	0.5173	0.5172	0.5169	0.5168	0.5165
11	3141K	0.5185	0.5180	0.5177	0.5175	0.5174	0.5169	0.5166	0.5164	0.5163	0.5161	0.5158
12	3146K	0.5193	0.5190	0.5187	0.5184	0.5183	0.5178	0.5175	0.5173	0.5172	0.5170	0.5168
13	3144K	0.5203	0.5196	0.5192	0.5189	0.5189	0.5184	0.5181	0.5179	0.5177	0.5175	0.5173
14	3150K	0.5173	0.5170	0.5167	0.5164	0.5163	0.5160	0.5156	0.5154	0.5152	0.5150	0.5148
15	3142K	0.5216	0.5211	0.5210	0.5206	0.5206	0.5202	0.5198	0.5196	0.5195	0.5193	0.5191
16	3133K	0.5182	0.5178	0.5176	0.5173	0.5173	0.5169	0.5165	0.5163	0.5161	0.5159	0.5156
17	3109K	0.5201	0.5195	0.5193	0.5190	0.5189	0.5184	0.5180	0.5178	0.5177	0.5175	0.5173
18	3136K	0.5181	0.5176	0.5174	0.5171	0.5171	0.5167	0.5163	0.5161	0.5158	0.5157	0.5154
19	3149K	0.5193	0.5189	0.5187	0.5183	0.5183	0.5178	0.5175	0.5173	0.5171	0.5170	0.5167
20	3143K	0.5183	0.5179	0.5177	0.5173	0.5173	0.5169	0.5165	0.5163	0.5161	0.5160	0.5157
21	3121K	0.5191	0.5186	0.5183	0.5180	0.5180	0.5175	0.5172	0.5171	0.5168	0.5166	0.5164
22	3096K	0.5186	0.5183	0.5180	0.5174	0.5174	0.5170	0.5166	0.5164	0.5162	0.5160	0.5158
23	3134K	0.5202	0.5197	0.5195	0.5191	0.5191	0.5187	0.5183	0.5182	0.5179	0.5177	0.5174
24	3142K	0.5202	0.5199	0.5196	0.5193	0.5193	0.5189	0.5185	0.5183	0.5181	0.5182	0.5177
25	3156K	0.5176	0.5172	0.5169	0.5165	0.5165	0.5160	0.5158	0.5156	0.5154	0.5152	0.5149

**Delta u'v' data for tested units**

$T_s = T_{air} = 105^{\circ}\text{C}$ ,  $I_f = 120\text{mA}$ ;  $T_s \geq 103^{\circ}\text{C}$  and  $T_{air} \geq 100^{\circ}\text{C}$  in compliance with LM-80-15

	CCT (t=0)	0hrs	1000hrs	2000hrs	3000hrs	4000hrs	5000hrs	6000hrs	7000hrs	8000hrs	9000hrs	10000hrs
1	3070K	0.0000	0.0007	0.0010	0.0012	0.0014	0.0017	0.0019	0.0020	0.0024	0.0028	0.0032
2	3078K	0.0000	0.0013	0.0014	0.0020	0.0024	0.0027	0.0028	0.0031	0.0035	0.0038	0.0042
3	3133K	0.0000	0.0006	0.0009	0.0012	0.0014	0.0017	0.0018	0.0022	0.0025	0.0028	0.0031
4	3136K	0.0000	0.0008	0.0010	0.0013	0.0015	0.0018	0.0019	0.0023	0.0026	0.0028	0.0033
5	2980K	0.0000	0.0002	0.0007	0.0009	0.0008	0.0012	0.0017	0.0021	0.0020	0.0024	0.0024
6	3140K	0.0000	0.0010	0.0013	0.0016	0.0017	0.0022	0.0023	0.0026	0.0028	0.0032	0.0032
7	3130K	0.0000	0.0005	0.0008	0.0011	0.0013	0.0016	0.0019	0.0022	0.0027	0.0030	0.0030
8	3094K	0.0000	0.0006	0.0009	0.0012	0.0014	0.0017	0.0019	0.0022	0.0024	0.0029	0.0030
9	3000K	0.0000	0.0005	0.0008	0.0011	0.0012	0.0016	0.0019	0.0020	0.0023	0.0025	0.0028
10	3139K	0.0000	0.0004	0.0006	0.0010	0.0011	0.0016	0.0018	0.0019	0.0023	0.0025	0.0028
11	3141K	0.0000	0.0006	0.0008	0.0010	0.0013	0.0017	0.0019	0.0022	0.0023	0.0026	0.0029
12	3146K	0.0000	0.0004	0.0006	0.0009	0.0012	0.0016	0.0018	0.0021	0.0022	0.0025	0.0027
13	3144K	0.0000	0.0008	0.0011	0.0014	0.0016	0.0020	0.0022	0.0025	0.0027	0.0030	0.0032
14	3150K	0.0000	0.0003	0.0006	0.0009	0.0011	0.0014	0.0017	0.0020	0.0022	0.0025	0.0027
15	3142K	0.0000	0.0006	0.0006	0.0010	0.0012	0.0015	0.0018	0.0021	0.0022	0.0026	0.0027
16	3133K	0.0000	0.0005	0.0006	0.0009	0.0011	0.0014	0.0017	0.0020	0.0022	0.0026	0.0029
17	3109K	0.0000	0.0008	0.0009	0.0012	0.0016	0.0020	0.0022	0.0025	0.0027	0.0030	0.0032
18	3136K	0.0000	0.0006	0.0007	0.0010	0.0012	0.0015	0.0018	0.0021	0.0025	0.0027	0.0030
19	3149K	0.0000	0.0005	0.0006	0.0010	0.0012	0.0017	0.0018	0.0021	0.0024	0.0026	0.0029
20	3143K	0.0000	0.0004	0.0006	0.0010	0.0012	0.0015	0.0018	0.0021	0.0023	0.0025	0.0029
21	3121K	0.0000	0.0006	0.0008	0.0011	0.0013	0.0017	0.0019	0.0021	0.0024	0.0028	0.0030
22	3096K	0.0000	0.0004	0.0006	0.0013	0.0014	0.0018	0.0020	0.0023	0.0026	0.0029	0.0031
23	3134K	0.0000	0.0007	0.0007	0.0012	0.0014	0.0017	0.0019	0.0021	0.0025	0.0028	0.0030
24	3142K	0.0000	0.0004	0.0006	0.0009	0.0011	0.0015	0.0017	0.0020	0.0022	0.0022	0.0027
25	3156K	0.0000	0.0005	0.0007	0.0011	0.0013	0.0017	0.0018	0.0021	0.0023	0.0027	0.0030

**Forward Voltage [V] data for tested units**

$T_s = T_{air} = 105^{\circ}\text{C}$ ,  $I_f = 120\text{mA}$ ;  $T_s \geq 103^{\circ}\text{C}$  and  $T_{air} \geq 100^{\circ}\text{C}$  in compliance with LM-80-15

	CCT (t=0)	0hrs	1000hrs	2000hrs	3000hrs	4000hrs	5000hrs	6000hrs	7000hrs	8000hrs	9000hrs	10000hrs
1	3070K	5.787	5.784	5.784	5.800	5.785	5.801	5.789	5.782	5.780	5.779	5.782
2	3078K	5.864	5.867	5.928	5.876	5.874	5.881	5.889	5.859	5.860	5.864	5.858
3	3133K	5.830	5.843	5.833	5.880	5.841	5.844	5.830	5.823	5.822	5.824	5.827
4	3136K	5.784	6.032	5.786	5.794	5.785	5.790	5.820	5.788	5.781	5.783	5.785
5	2980K	5.843	5.839	5.844	5.875	5.851	5.850	5.846	5.844	5.837	5.843	5.845
6	3140K	5.881	5.875	5.890	5.890	5.883	5.898	5.888	5.884	5.876	5.962	5.880
7	3130K	5.832	5.828	5.836	6.025	5.869	5.851	5.902	5.837	5.827	5.828	5.830
8	3094K	5.855	5.852	5.855	5.874	5.857	5.866	5.863	5.861	5.849	5.854	5.855
9	3000K	5.889	5.942	5.900	5.902	5.896	5.889	5.928	5.890	6.068	5.887	5.886
10	3139K	5.905	5.885	5.886	5.908	5.927	5.885	5.895	5.889	5.883	5.889	5.882
11	3141K	5.948	5.860	5.879	5.901	5.866	5.909	5.866	5.869	5.860	5.866	5.860
12	3146K	5.871	5.866	5.885	5.940	5.871	5.868	5.872	5.869	5.880	5.868	5.867
13	3144K	5.835	5.836	5.841	5.953	5.841	6.010	5.842	5.847	5.831	5.834	5.833
14	3150K	5.820	5.801	5.796	5.808	5.803	5.801	5.806	5.795	5.792	5.793	5.792
15	3142K	5.861	5.801	5.850	5.810	5.796	6.022	5.830	5.801	5.789	5.794	5.794
16	3133K	5.887	5.820	5.839	5.837	5.824	6.071	5.828	5.832	5.818	5.829	5.825
17	3109K	5.904	5.886	5.880	5.894	5.885	5.907	5.885	5.900	5.881	5.881	5.878
18	3136K	5.886	5.882	5.872	5.933	5.873	5.880	5.878	5.869	5.863	5.870	5.868
19	3149K	5.866	5.867	5.876	5.885	5.871	5.997	5.870	5.871	5.861	5.867	5.863
20	3143K	5.838	5.845	5.950	5.862	5.890	5.899	5.847	5.840	5.838	5.845	5.840
21	3121K	5.882	5.884	5.880	6.089	5.892	5.891	5.919	5.887	5.874	5.879	5.879
22	3096K	5.868	5.920	5.857	5.867	5.867	5.865	5.861	5.866	5.858	5.856	5.854
23	3134K	5.837	5.838	5.840	5.865	5.850	5.841	5.845	5.842	5.835	5.840	5.838
24	3142K	5.957	6.098	5.872	5.938	5.896	6.061	5.873	5.870	5.863	5.866	5.866
25	3156K	5.840	5.842	5.841	5.901	5.844	5.841	5.844	5.841	5.833	5.840	5.842

**Luminous Flux [lm] data for tested units**

$T_s = T_{air} = 115^{\circ}C, I_f = 120mA; T_s \geq 113^{\circ}C$  and  $T_{air} \geq 110^{\circ}C$  in compliance with LM-80-15

	CCT (t=0)	0hrs	1000hrs	2000hrs	3000hrs	4000hrs	5000hrs	6000hrs	7000hrs	8000hrs	9000hrs	10000hrs
1	3165K	128.000	127.800	127.500	127.300	127.000	126.500	126.300	126.000	125.700	125.300	124.900
2	3117K	125.900	125.600	125.400	125.100	124.800	124.600	124.300	124.000	123.800	123.300	123.100
3	3116K	127.500	127.300	126.900	126.700	126.400	125.900	125.800	125.400	125.100	124.900	124.800
4	3129K	127.900	127.200	126.800	126.600	126.100	125.700	125.400	125.100	124.800	124.300	123.900
5	3131K	126.800	126.900	126.600	126.100	125.700	125.300	125.100	125.000	124.500	124.300	123.800
6	3120K	126.400	126.200	125.700	125.400	124.900	124.500	124.200	123.900	123.700	123.400	123.100
7	3115K	128.200	127.500	127.000	126.500	126.000	125.600	125.400	125.100	124.700	124.300	123.900
8	3123K	124.800	124.200	123.600	123.200	122.600	122.100	121.900	121.500	121.400	121.000	120.600
9	2972K	126.600	126.500	126.200	126.000	125.700	125.500	125.200	124.900	124.600	124.300	123.900
10	3140K	128.100	128.200	127.700	127.300	127.000	126.700	126.400	126.100	125.800	125.600	125.300
11	3093K	128.100	128.000	127.600	127.200	126.700	126.400	126.200	125.900	125.600	125.200	124.800
12	3135K	127.400	127.000	126.700	126.400	125.900	125.600	125.300	125.100	124.900	124.500	124.000
13	3143K	128.500	128.400	127.800	127.400	127.200	126.900	126.800	126.500	126.300	125.800	125.500
14	3170K	127.200	126.800	126.300	125.800	125.400	125.200	125.100	124.700	124.400	124.100	123.700
15	3142K	128.300	127.600	127.100	126.800	126.200	125.900	125.700	125.300	124.900	124.600	124.300
16	3103K	126.700	126.200	125.800	125.400	125.000	124.500	124.300	123.900	123.700	123.300	122.900
17	3132K	129.100	128.800	128.300	128.100	127.700	127.500	127.300	126.900	126.400	126.000	125.600
18	2974K	126.200	125.900	125.500	125.200	124.800	124.400	124.300	124.100	124.000	123.800	123.400
19	3137K	125.700	125.300	124.900	124.700	124.200	123.800	123.600	123.200	122.800	122.500	122.200
20	3117K	128.300	128.100	127.600	127.300	126.800	126.400	126.100	125.900	125.500	125.000	124.400
21	3128K	128.300	127.900	127.500	127.100	126.800	126.200	126.000	125.800	125.500	125.000	124.500
22	3141K	127.600	127.100	126.600	126.100	125.600	125.200	124.900	124.600	124.200	123.900	123.600
23	3114K	126.200	125.600	125.100	124.600	124.000	123.400	123.200	123.000	122.600	122.300	121.900
24	3115K	128.300	127.700	127.300	127.000	126.600	126.000	125.800	125.600	125.500	125.100	124.900
25	3117K	125.300	124.900	124.600	124.200	123.800	123.400	123.200	122.800	122.500	122.100	121.800

**Normalized Luminous Flux data for tested units**

$T_s = T_{air} = 115^{\circ}C, I_f = 120mA; T_s \geq 113^{\circ}C$  and  $T_{air} \geq 110^{\circ}C$  in compliance with LM-80-15

	CCT (t=0)	0hrs	1000hrs	2000hrs	3000hrs	4000hrs	5000hrs	6000hrs	7000hrs	8000hrs	9000hrs	10000hrs
1	3165K	1.0000	0.9984	0.9961	0.9945	0.9922	0.9883	0.9867	0.9844	0.9820	0.9789	0.9758
2	3117K	1.0000	0.9976	0.9960	0.9936	0.9913	0.9897	0.9873	0.9849	0.9833	0.9793	0.9778
3	3116K	1.0000	0.9984	0.9953	0.9937	0.9914	0.9875	0.9867	0.9835	0.9812	0.9796	0.9788
4	3129K	1.0000	0.9945	0.9914	0.9898	0.9859	0.9828	0.9805	0.9781	0.9758	0.9719	0.9687
5	3131K	1.0000	1.0008	0.9984	0.9945	0.9913	0.9882	0.9866	0.9858	0.9819	0.9803	0.9763
6	3120K	1.0000	0.9984	0.9945	0.9921	0.9881	0.9850	0.9826	0.9802	0.9786	0.9763	0.9739
7	3115K	1.0000	0.9945	0.9906	0.9867	0.9828	0.9797	0.9782	0.9758	0.9727	0.9696	0.9665
8	3123K	1.0000	0.9952	0.9904	0.9872	0.9824	0.9784	0.9768	0.9736	0.9728	0.9696	0.9663
9	2972K	1.0000	0.9992	0.9968	0.9953	0.9929	0.9913	0.9889	0.9866	0.9842	0.9818	0.9787
10	3140K	1.0000	1.0008	0.9969	0.9938	0.9914	0.9891	0.9867	0.9844	0.9820	0.9805	0.9781
11	3093K	1.0000	0.9992	0.9961	0.9930	0.9891	0.9867	0.9852	0.9828	0.9805	0.9774	0.9742
12	3135K	1.0000	0.9969	0.9945	0.9922	0.9882	0.9859	0.9835	0.9819	0.9804	0.9772	0.9733
13	3143K	1.0000	0.9992	0.9946	0.9914	0.9899	0.9875	0.9868	0.9844	0.9829	0.9790	0.9767
14	3170K	1.0000	0.9969	0.9929	0.9890	0.9858	0.9843	0.9835	0.9803	0.9780	0.9756	0.9725
15	3142K	1.0000	0.9945	0.9906	0.9883	0.9836	0.9813	0.9797	0.9766	0.9735	0.9712	0.9688
16	3103K	1.0000	0.9961	0.9929	0.9897	0.9866	0.9826	0.9811	0.9779	0.9763	0.9732	0.9700
17	3132K	1.0000	0.9977	0.9938	0.9923	0.9892	0.9876	0.9861	0.9830	0.9791	0.9760	0.9729
18	2974K	1.0000	0.9976	0.9945	0.9921	0.9889	0.9857	0.9849	0.9834	0.9826	0.9810	0.9778
19	3137K	1.0000	0.9968	0.9936	0.9920	0.9881	0.9849	0.9833	0.9801	0.9769	0.9745	0.9730
20	3117K	1.0000	0.9984	0.9945	0.9922	0.9883	0.9852	0.9829	0.9813	0.9782	0.9743	0.9696
21	3128K	1.0000	0.9969	0.9938	0.9906	0.9883	0.9836	0.9821	0.9805	0.9782	0.9743	0.9704
22	3141K	1.0000	0.9961	0.9922	0.9882	0.9843	0.9812	0.9788	0.9765	0.9734	0.9710	0.9687
23	3114K	1.0000	0.9952	0.9913	0.9873	0.9826	0.9778	0.9762	0.9746	0.9715	0.9691	0.9659
24	3115K	1.0000	0.9953	0.9922	0.9899	0.9867	0.9821	0.9805	0.9790	0.9782	0.9751	0.9735
25	3117K	1.0000	0.9968	0.9944	0.9912	0.9880	0.9848	0.9832	0.9800	0.9777	0.9745	0.9721

**CIE 1976 u' data for tested units**

$T_s = T_{air} = 115^{\circ}\text{C}$ ,  $I_f = 120\text{mA}$ ;  $T_s \geq 113^{\circ}\text{C}$  and  $T_{air} \geq 110^{\circ}\text{C}$  in compliance with LM-80-15

	CCT (t=0)	0hrs	1000hrs	2000hrs	3000hrs	4000hrs	5000hrs	6000hrs	7000hrs	8000hrs	9000hrs	10000hrs
1	3165K	0.2448	0.2446	0.2447	0.2446	0.2442	0.2442	0.2446	0.2443	0.2441	0.2438	0.2437
2	3117K	0.2469	0.2466	0.2467	0.2464	0.2459	0.2461	0.2463	0.2461	0.2459	0.2456	0.2454
3	3116K	0.2463	0.2458	0.2457	0.2456	0.2451	0.2452	0.2455	0.2452	0.2450	0.2447	0.2447
4	3129K	0.2459	0.2457	0.2457	0.2455	0.2451	0.2451	0.2454	0.2451	0.2449	0.2446	0.2445
5	3131K	0.2462	0.2458	0.2459	0.2457	0.2453	0.2454	0.2456	0.2454	0.2452	0.2449	0.2448
6	3120K	0.2465	0.2462	0.2462	0.2461	0.2457	0.2458	0.2460	0.2458	0.2455	0.2453	0.2453
7	3115K	0.2469	0.2466	0.2466	0.2465	0.2460	0.2461	0.2462	0.2460	0.2457	0.2454	0.2455
8	3123K	0.2467	0.2465	0.2465	0.2464	0.2461	0.2461	0.2464	0.2462	0.2458	0.2456	0.2456
9	2972K	0.2509	0.2507	0.2507	0.2505	0.2501	0.2502	0.2504	0.2502	0.2499	0.2496	0.2497
10	3140K	0.2462	0.2459	0.2460	0.2459	0.2455	0.2455	0.2457	0.2455	0.2451	0.2449	0.2449
11	3093K	0.2476	0.2474	0.2473	0.2472	0.2468	0.2469	0.2471	0.2468	0.2466	0.2463	0.2463
12	3135K	0.2460	0.2457	0.2457	0.2456	0.2452	0.2453	0.2455	0.2453	0.2450	0.2447	0.2447
13	3143K	0.2456	0.2454	0.2454	0.2453	0.2449	0.2449	0.2451	0.2449	0.2447	0.2444	0.2444
14	3170K	0.2449	0.2448	0.2448	0.2446	0.2442	0.2443	0.2445	0.2442	0.2440	0.2437	0.2438
15	3142K	0.2455	0.2453	0.2453	0.2452	0.2447	0.2447	0.2450	0.2448	0.2445	0.2441	0.2442
16	3103K	0.2471	0.2469	0.2469	0.2468	0.2464	0.2465	0.2466	0.2465	0.2462	0.2459	0.2459
17	3132K	0.2455	0.2452	0.2452	0.2450	0.2446	0.2447	0.2449	0.2447	0.2445	0.2442	0.2442
18	2974K	0.2509	0.2508	0.2508	0.2506	0.2502	0.2503	0.2506	0.2504	0.2501	0.2498	0.2498
19	3137K	0.2462	0.2460	0.2460	0.2459	0.2454	0.2455	0.2457	0.2455	0.2453	0.2450	0.2449
20	3117K	0.2468	0.2466	0.2467	0.2465	0.2461	0.2462	0.2464	0.2462	0.2459	0.2457	0.2457
21	3128K	0.2462	0.2459	0.2459	0.2457	0.2452	0.2454	0.2456	0.2455	0.2452	0.2449	0.2449
22	3141K	0.2454	0.2451	0.2451	0.2451	0.2447	0.2448	0.2450	0.2448	0.2445	0.2442	0.2442
23	3114K	0.2470	0.2468	0.2469	0.2467	0.2463	0.2464	0.2466	0.2464	0.2462	0.2458	0.2458
24	3115K	0.2468	0.2464	0.2464	0.2463	0.2459	0.2461	0.2461	0.2459	0.2456	0.2453	0.2453
25	3117K	0.2469	0.2466	0.2466	0.2465	0.2461	0.2463	0.2464	0.2462	0.2461	0.2457	0.2457

**CIE 1976 v' data for tested units**

$T_s = T_{air} = 115^{\circ}\text{C}$ ,  $I_f = 120\text{mA}$ ;  $T_s \geq 113^{\circ}\text{C}$  and  $T_{air} \geq 110^{\circ}\text{C}$  in compliance with LM-80-15

	CCT (t=0)	0hrs	1000hrs	2000hrs	3000hrs	4000hrs	5000hrs	6000hrs	7000hrs	8000hrs	9000hrs	10000hrs
1	3165K	0.5189	0.5182	0.5180	0.5178	0.5178	0.5173	0.5170	0.5167	0.5166	0.5165	0.5161
2	3117K	0.5178	0.5171	0.5169	0.5166	0.5166	0.5161	0.5157	0.5155	0.5153	0.5152	0.5148
3	3116K	0.5201	0.5192	0.5189	0.5186	0.5185	0.5181	0.5177	0.5174	0.5173	0.5172	0.5168
4	3129K	0.5198	0.5191	0.5188	0.5186	0.5185	0.5181	0.5177	0.5174	0.5173	0.5172	0.5168
5	3131K	0.5184	0.5177	0.5174	0.5171	0.5171	0.5167	0.5163	0.5160	0.5159	0.5158	0.5155
6	3120K	0.5189	0.5182	0.5179	0.5177	0.5177	0.5172	0.5168	0.5166	0.5165	0.5164	0.5160
7	3115K	0.5181	0.5173	0.5170	0.5167	0.5167	0.5163	0.5157	0.5155	0.5153	0.5152	0.5148
8	3123K	0.5177	0.5172	0.5169	0.5166	0.5166	0.5163	0.5158	0.5155	0.5154	0.5153	0.5149
9	2972K	0.5246	0.5240	0.5237	0.5234	0.5234	0.5230	0.5226	0.5223	0.5222	0.5222	0.5218
10	3140K	0.5172	0.5166	0.5163	0.5161	0.5161	0.5157	0.5152	0.5150	0.5148	0.5148	0.5144
11	3093K	0.5187	0.5181	0.5178	0.5175	0.5175	0.5171	0.5166	0.5164	0.5162	0.5162	0.5157
12	3135K	0.5186	0.5179	0.5176	0.5174	0.5174	0.5170	0.5165	0.5163	0.5161	0.5160	0.5156
13	3143K	0.5190	0.5184	0.5181	0.5178	0.5178	0.5174	0.5170	0.5167	0.5166	0.5165	0.5161
14	3170K	0.5179	0.5174	0.5171	0.5168	0.5168	0.5164	0.5159	0.5157	0.5156	0.5156	0.5151
15	3142K	0.5194	0.5187	0.5184	0.5181	0.5181	0.5177	0.5173	0.5171	0.5169	0.5168	0.5165
16	3103K	0.5190	0.5185	0.5182	0.5179	0.5179	0.5175	0.5170	0.5168	0.5167	0.5166	0.5163
17	3132K	0.5208	0.5202	0.5199	0.5196	0.5196	0.5192	0.5187	0.5185	0.5185	0.5183	0.5180
18	2974K	0.5242	0.5237	0.5234	0.5231	0.5231	0.5227	0.5222	0.5220	0.5219	0.5219	0.5215
19	3137K	0.5176	0.5170	0.5167	0.5164	0.5164	0.5160	0.5156	0.5153	0.5153	0.5151	0.5147
20	3117K	0.5182	0.5176	0.5174	0.5171	0.5170	0.5167	0.5162	0.5160	0.5159	0.5157	0.5154
21	3128K	0.5188	0.5181	0.5177	0.5175	0.5174	0.5170	0.5165	0.5163	0.5163	0.5161	0.5158
22	3141K	0.5199	0.5193	0.5190	0.5188	0.5188	0.5185	0.5180	0.5177	0.5175	0.5173	0.5170
23	3114K	0.5179	0.5174	0.5171	0.5168	0.5168	0.5164	0.5159	0.5157	0.5157	0.5155	0.5151
24	3115K	0.5185	0.5178	0.5175	0.5172	0.5172	0.5169	0.5163	0.5161	0.5160	0.5157	0.5154
25	3117K	0.5179	0.5173	0.5170	0.5167	0.5167	0.5163	0.5158	0.5157	0.5156	0.5154	0.5151

**Delta u'v' data for tested units**

$T_s = T_{air} = 115^\circ\text{C}$ ,  $I_f = 120\text{mA}$ ;  $T_s \geq 113^\circ\text{C}$  and  $T_{air} \geq 110^\circ\text{C}$  in compliance with LM-80-15

	CCT (t=0)	0hrs	1000hrs	2000hrs	3000hrs	4000hrs	5000hrs	6000hrs	7000hrs	8000hrs	9000hrs	10000hrs
1	3165K	0.0000	0.0007	0.0009	0.0011	0.0013	0.0017	0.0019	0.0023	0.0024	0.0026	0.0030
2	3117K	0.0000	0.0008	0.0009	0.0013	0.0016	0.0019	0.0022	0.0024	0.0027	0.0029	0.0034
3	3116K	0.0000	0.0010	0.0013	0.0017	0.0020	0.0023	0.0025	0.0029	0.0031	0.0033	0.0037
4	3129K	0.0000	0.0007	0.0010	0.0013	0.0015	0.0019	0.0022	0.0025	0.0027	0.0029	0.0033
5	3131K	0.0000	0.0008	0.0010	0.0014	0.0016	0.0019	0.0022	0.0025	0.0027	0.0029	0.0032
6	3120K	0.0000	0.0008	0.0010	0.0013	0.0014	0.0018	0.0022	0.0024	0.0026	0.0028	0.0031
7	3115K	0.0000	0.0009	0.0011	0.0015	0.0017	0.0020	0.0025	0.0028	0.0030	0.0033	0.0036
8	3123K	0.0000	0.0005	0.0008	0.0011	0.0013	0.0015	0.0019	0.0023	0.0025	0.0026	0.0030
9	2972K	0.0000	0.0006	0.0009	0.0013	0.0014	0.0017	0.0021	0.0024	0.0026	0.0027	0.0030
10	3140K	0.0000	0.0007	0.0009	0.0011	0.0013	0.0017	0.0021	0.0023	0.0026	0.0027	0.0031
11	3093K	0.0000	0.0006	0.0009	0.0013	0.0014	0.0017	0.0022	0.0024	0.0027	0.0028	0.0033
12	3135K	0.0000	0.0008	0.0010	0.0013	0.0014	0.0017	0.0022	0.0024	0.0027	0.0029	0.0033
13	3143K	0.0000	0.0006	0.0009	0.0012	0.0014	0.0017	0.0021	0.0024	0.0026	0.0028	0.0031
14	3170K	0.0000	0.0005	0.0008	0.0011	0.0013	0.0016	0.0020	0.0023	0.0025	0.0026	0.0030
15	3142K	0.0000	0.0007	0.0010	0.0013	0.0015	0.0019	0.0022	0.0024	0.0027	0.0030	0.0032
16	3103K	0.0000	0.0005	0.0008	0.0011	0.0013	0.0016	0.0021	0.0023	0.0025	0.0027	0.0030
17	3132K	0.0000	0.0007	0.0009	0.0013	0.0015	0.0018	0.0022	0.0024	0.0025	0.0028	0.0031
18	2974K	0.0000	0.0005	0.0008	0.0011	0.0013	0.0016	0.0020	0.0023	0.0024	0.0025	0.0029
19	3137K	0.0000	0.0006	0.0009	0.0012	0.0014	0.0017	0.0021	0.0024	0.0025	0.0028	0.0032
20	3117K	0.0000	0.0006	0.0008	0.0011	0.0014	0.0016	0.0020	0.0023	0.0025	0.0027	0.0030
21	3128K	0.0000	0.0008	0.0011	0.0014	0.0017	0.0020	0.0024	0.0026	0.0027	0.0030	0.0033
22	3141K	0.0000	0.0007	0.0009	0.0011	0.0013	0.0015	0.0019	0.0023	0.0026	0.0029	0.0031
23	3114K	0.0000	0.0005	0.0008	0.0011	0.0013	0.0016	0.0020	0.0023	0.0023	0.0027	0.0030
24	3115K	0.0000	0.0008	0.0011	0.0014	0.0016	0.0017	0.0023	0.0026	0.0028	0.0032	0.0034
25	3117K	0.0000	0.0007	0.0009	0.0013	0.0014	0.0017	0.0022	0.0023	0.0024	0.0028	0.0030

**Forward Voltage [V] data for tested units**

$T_s = T_{air} = 115^\circ\text{C}$ ,  $I_f = 120\text{mA}$ ;  $T_s \geq 113^\circ\text{C}$  and  $T_{air} \geq 110^\circ\text{C}$  in compliance with LM-80-15

	CCT (t=0)	0hrs	1000hrs	2000hrs	3000hrs	4000hrs	5000hrs	6000hrs	7000hrs	8000hrs	9000hrs	10000hrs
1	3165K	5.869	5.915	5.867	5.882	5.868	5.872	5.876	5.870	5.861	5.867	5.868
2	3117K	5.951	5.844	5.859	5.848	5.838	5.872	5.842	5.838	5.828	5.835	5.837
3	3116K	5.813	5.824	5.815	5.851	5.847	5.999	5.911	5.837	5.995	5.835	5.812
4	3129K	5.854	6.037	5.856	5.943	6.088	5.958	5.863	5.875	5.857	5.855	5.858
5	3131K	5.830	5.982	5.836	5.849	5.839	5.984	5.841	5.838	5.825	5.834	5.831
6	3120K	5.889	5.906	5.886	5.900	5.899	5.837	5.992	6.070	5.931	5.885	5.885
7	3115K	5.837	5.829	5.830	5.845	5.908	5.909	5.848	5.832	5.821	5.828	5.826
8	3123K	5.919	5.840	5.848	5.852	5.880	6.138	5.851	5.843	5.838	5.845	5.840
9	2972K	5.860	5.878	5.856	5.881	5.855	5.859	5.861	5.854	5.849	5.854	5.850
10	3140K	5.819	5.835	5.824	5.887	5.934	5.899	5.818	5.812	5.821	5.811	5.812
11	3093K	5.864	5.864	5.855	5.875	5.868	5.889	5.886	5.869	5.855	5.869	5.856
12	3135K	5.875	5.940	5.882	5.894	5.883	6.019	5.884	5.881	5.873	5.882	5.878
13	3143K	5.840	5.950	5.840	5.895	5.931	5.976	5.841	5.865	5.843	5.836	5.837
14	3170K	5.960	5.932	5.880	6.086	5.888	5.943	5.889	5.968	5.873	5.883	5.888
15	3142K	5.877	5.909	5.878	5.888	5.910	6.115	5.881	5.876	5.867	5.881	5.876
16	3103K	5.854	5.843	5.788	5.844	5.803	5.793	5.791	5.790	5.783	5.790	5.786
17	3132K	5.845	5.846	6.075	5.866	5.850	5.867	5.960	5.849	5.844	5.846	5.844
18	2974K	5.853	6.103	5.850	5.896	5.904	6.136	5.851	5.851	5.865	5.954	5.847
19	3137K	5.902	5.888	5.875	6.212	5.855	6.063	5.858	5.855	5.852	5.852	5.851
20	3117K	5.858	6.096	5.865	5.891	5.866	6.154	5.874	5.862	5.870	5.860	5.863
21	3128K	5.947	5.913	5.844	5.895	5.861	5.867	5.850	5.844	5.858	5.998	5.844
22	3141K	5.842	5.872	5.850	5.854	5.951	5.943	5.842	5.839	5.876	5.837	5.837
23	3114K	5.785	5.801	5.789	5.946	5.811	6.100	5.793	5.791	5.786	5.787	5.789
24	3115K	5.879	5.967	5.882	5.909	5.895	5.886	5.887	5.886	5.882	5.886	5.882
25	3117K	5.832	6.055	5.835	5.875	5.840	5.870	5.841	5.839	5.834	5.841	5.841

**Luminous Flux [lm] data for tested units**

$T_s = T_{air} = 105^{\circ}C, I_f = 150mA; T_s \geq 103^{\circ}C$  and  $T_{air} \geq 100^{\circ}C$  in compliance with LM-80-15

	CCT (t=0)	0hrs	1000hrs	2000hrs	3000hrs	4000hrs	5000hrs	6000hrs	7000hrs	8000hrs	9000hrs	10000hrs
1	3006K	155.200	154.700	154.100	153.700	153.200	152.700	152.200	152.000	151.500	151.000	150.500
2	3148K	155.400	154.800	154.300	153.700	153.100	152.600	152.100	151.700	151.200	150.900	150.400
3	3132K	156.900	156.100	155.400	154.800	154.400	154.100	153.700	153.500	152.900	152.500	152.100
4	3127K	154.700	154.100	153.700	153.200	152.500	151.900	151.600	151.400	151.000	150.700	150.500
5	3147K	155.500	155.200	154.900	154.500	154.000	153.600	153.200	152.800	152.300	151.900	151.300
6	3139K	155.400	155.200	154.600	154.400	153.800	153.300	152.700	152.300	151.900	151.400	151.100
7	3161K	156.200	155.400	155.000	154.400	154.000	153.400	153.000	152.500	152.100	151.600	151.200
8	3156K	154.800	153.900	153.500	152.900	152.300	151.800	151.500	151.000	150.500	149.900	149.400
9	3145K	153.000	153.200	152.700	152.300	152.000	151.400	150.700	150.400	150.100	149.700	149.300
10	3114K	157.200	156.400	156.000	155.500	154.900	154.200	153.800	153.500	153.000	152.500	152.000
11	3106K	155.200	154.900	154.400	153.800	153.300	152.800	152.300	151.900	151.500	151.200	150.800
12	3163K	154.700	154.200	153.800	153.600	152.900	152.600	152.200	151.800	151.300	150.700	150.300
13	3161K	153.800	153.100	152.900	152.300	151.700	151.200	150.700	150.600	150.200	150.000	149.400
14	3130K	156.200	155.600	155.200	154.600	154.100	153.600	153.400	153.200	152.900	152.400	151.900
15	3127K	153.500	153.300	152.800	152.200	151.900	151.500	151.000	150.400	150.000	149.600	149.300
16	3127K	154.000	153.300	152.900	152.400	151.700	151.100	150.800	150.300	150.100	149.700	149.000
17	3109K	153.800	153.300	152.600	152.400	151.900	151.500	151.100	150.700	150.500	150.000	149.300
18	2967K	154.200	153.800	153.200	152.800	152.200	151.800	151.600	151.000	150.600	150.400	149.800
19	3158K	154.900	154.400	154.100	153.800	153.100	152.800	152.200	152.000	151.600	151.200	150.600
20	3129K	153.700	153.100	152.600	152.200	151.900	151.500	151.100	150.700	150.400	149.900	149.800
21	3107K	158.000	157.100	156.700	156.100	155.800	155.600	155.100	154.400	154.200	153.700	153.500
22	3133K	154.600	153.900	153.200	152.800	152.100	151.600	151.200	150.600	150.200	149.800	149.300
23	2988K	158.200	157.500	156.800	156.500	156.100	155.500	155.000	154.900	154.300	153.600	153.200
24	3130K	156.000	155.200	154.700	154.300	153.700	153.300	152.600	152.200	151.900	151.300	150.800
25	3127K	153.200	153.000	152.400	151.900	151.200	150.700	150.400	149.800	149.400	149.200	148.400

**Normalized Luminous Flux data for tested units**

$T_s = T_{air} = 105^{\circ}C, I_f = 150mA; T_s \geq 103^{\circ}C$  and  $T_{air} \geq 100^{\circ}C$  in compliance with LM-80-15

	CCT (t=0)	0hrs	1000hrs	2000hrs	3000hrs	4000hrs	5000hrs	6000hrs	7000hrs	8000hrs	9000hrs	10000hrs
1	3006K	1.0000	0.9968	0.9929	0.9903	0.9871	0.9839	0.9807	0.9794	0.9762	0.9729	0.9697
2	3148K	1.0000	0.9961	0.9929	0.9891	0.9852	0.9820	0.9788	0.9762	0.9730	0.9710	0.9678
3	3132K	1.0000	0.9949	0.9904	0.9866	0.9841	0.9822	0.9796	0.9783	0.9745	0.9720	0.9694
4	3127K	1.0000	0.9961	0.9935	0.9903	0.9858	0.9819	0.9800	0.9787	0.9761	0.9741	0.9729
5	3147K	1.0000	0.9981	0.9961	0.9936	0.9904	0.9878	0.9852	0.9826	0.9794	0.9768	0.9730
6	3139K	1.0000	0.9987	0.9949	0.9936	0.9897	0.9865	0.9826	0.9801	0.9775	0.9743	0.9723
7	3161K	1.0000	0.9949	0.9923	0.9885	0.9859	0.9821	0.9795	0.9763	0.9738	0.9706	0.9680
8	3156K	1.0000	0.9942	0.9916	0.9877	0.9839	0.9806	0.9787	0.9755	0.9722	0.9683	0.9651
9	3145K	1.0000	1.0013	0.9980	0.9954	0.9935	0.9895	0.9850	0.9830	0.9810	0.9784	0.9758
10	3114K	1.0000	0.9949	0.9924	0.9892	0.9854	0.9809	0.9784	0.9765	0.9733	0.9701	0.9669
11	3106K	1.0000	0.9981	0.9948	0.9910	0.9878	0.9845	0.9813	0.9787	0.9762	0.9742	0.9716
12	3163K	1.0000	0.9968	0.9942	0.9929	0.9884	0.9864	0.9838	0.9813	0.9780	0.9741	0.9716
13	3161K	1.0000	0.9954	0.9941	0.9902	0.9863	0.9831	0.9798	0.9792	0.9766	0.9753	0.9714
14	3130K	1.0000	0.9962	0.9936	0.9898	0.9866	0.9834	0.9821	0.9808	0.9789	0.9757	0.9725
15	3127K	1.0000	0.9987	0.9954	0.9915	0.9896	0.9870	0.9837	0.9798	0.9772	0.9746	0.9726
16	3127K	1.0000	0.9955	0.9929	0.9896	0.9851	0.9812	0.9792	0.9760	0.9747	0.9721	0.9675
17	3109K	1.0000	0.9967	0.9922	0.9909	0.9876	0.9850	0.9824	0.9798	0.9785	0.9753	0.9707
18	2967K	1.0000	0.9974	0.9935	0.9909	0.9870	0.9844	0.9831	0.9792	0.9767	0.9754	0.9715
19	3158K	1.0000	0.9968	0.9948	0.9929	0.9884	0.9864	0.9826	0.9813	0.9787	0.9761	0.9722
20	3129K	1.0000	0.9961	0.9928	0.9902	0.9883	0.9857	0.9831	0.9805	0.9785	0.9753	0.9746
21	3107K	1.0000	0.9943	0.9918	0.9880	0.9861	0.9848	0.9816	0.9772	0.9759	0.9728	0.9715
22	3133K	1.0000	0.9955	0.9909	0.9884	0.9838	0.9806	0.9780	0.9741	0.9715	0.9690	0.9657
23	2988K	1.0000	0.9956	0.9912	0.9893	0.9867	0.9829	0.9798	0.9791	0.9753	0.9709	0.9684
24	3130K	1.0000	0.9949	0.9917	0.9891	0.9853	0.9827	0.9782	0.9756	0.9737	0.9699	0.9667
25	3127K	1.0000	0.9987	0.9948	0.9915	0.9869	0.9837	0.9817	0.9778	0.9752	0.9739	0.9687

**CIE 1976 u' data for tested units**

$T_s = T_{air} = 105^\circ\text{C}$ ,  $I_f = 150\text{mA}$ ;  $T_s \geq 103^\circ\text{C}$  and  $T_{air} \geq 100^\circ\text{C}$  in compliance with LM-80-15

	CCT (t=0)	0hrs	1000hrs	2000hrs	3000hrs	4000hrs	5000hrs	6000hrs	7000hrs	8000hrs	9000hrs	10000hrs
1	3006K	0.2494	0.2492	0.2492	0.2490	0.2486	0.2487	0.2490	0.2489	0.2485	0.2481	0.2482
2	3148K	0.2448	0.2444	0.2444	0.2443	0.2439	0.2439	0.2442	0.2440	0.2437	0.2433	0.2433
3	3132K	0.2460	0.2456	0.2456	0.2455	0.2451	0.2451	0.2454	0.2453	0.2449	0.2445	0.2445
4	3127K	0.2464	0.2460	0.2460	0.2458	0.2455	0.2455	0.2458	0.2457	0.2452	0.2448	0.2449
5	3147K	0.2452	0.2448	0.2448	0.2447	0.2443	0.2443	0.2446	0.2445	0.2440	0.2437	0.2436
6	3139K	0.2459	0.2455	0.2453	0.2453	0.2449	0.2450	0.2452	0.2451	0.2447	0.2444	0.2443
7	3161K	0.2451	0.2447	0.2447	0.2447	0.2443	0.2443	0.2446	0.2444	0.2439	0.2436	0.2436
8	3156K	0.2454	0.2449	0.2450	0.2449	0.2444	0.2444	0.2447	0.2446	0.2442	0.2438	0.2439
9	3145K	0.2457	0.2453	0.2453	0.2453	0.2449	0.2448	0.2452	0.2450	0.2447	0.2443	0.2443
10	3114K	0.2467	0.2462	0.2462	0.2461	0.2458	0.2458	0.2460	0.2459	0.2455	0.2452	0.2452
11	3106K	0.2473	0.2469	0.2469	0.2469	0.2465	0.2465	0.2467	0.2465	0.2462	0.2458	0.2458
12	3163K	0.2451	0.2447	0.2447	0.2447	0.2442	0.2443	0.2444	0.2444	0.2440	0.2437	0.2437
13	3161K	0.2453	0.2448	0.2449	0.2447	0.2443	0.2443	0.2446	0.2445	0.2441	0.2438	0.2438
14	3130K	0.2461	0.2457	0.2457	0.2457	0.2452	0.2452	0.2455	0.2453	0.2450	0.2447	0.2446
15	3127K	0.2463	0.2458	0.2458	0.2457	0.2453	0.2454	0.2456	0.2455	0.2452	0.2448	0.2448
16	3127K	0.2463	0.2458	0.2458	0.2457	0.2453	0.2453	0.2456	0.2454	0.2451	0.2447	0.2447
17	3109K	0.2469	0.2464	0.2465	0.2464	0.2459	0.2459	0.2462	0.2460	0.2458	0.2453	0.2451
18	2967K	0.2513	0.2508	0.2509	0.2509	0.2504	0.2505	0.2507	0.2505	0.2502	0.2498	0.2498
19	3158K	0.2455	0.2451	0.2451	0.2450	0.2445	0.2446	0.2448	0.2446	0.2444	0.2440	0.2439
20	3129K	0.2462	0.2456	0.2457	0.2457	0.2453	0.2453	0.2456	0.2453	0.2451	0.2448	0.2448
21	3107K	0.2469	0.2464	0.2464	0.2465	0.2459	0.2460	0.2462	0.2460	0.2457	0.2454	0.2455
22	3133K	0.2461	0.2457	0.2457	0.2456	0.2451	0.2452	0.2455	0.2452	0.2450	0.2447	0.2446
23	2988K	0.2496	0.2491	0.2491	0.2490	0.2486	0.2487	0.2489	0.2486	0.2483	0.2479	0.2480
24	3130K	0.2463	0.2458	0.2458	0.2457	0.2453	0.2453	0.2456	0.2453	0.2451	0.2447	0.2447
25	3127K	0.2460	0.2455	0.2456	0.2454	0.2450	0.2451	0.2453	0.2451	0.2449	0.2446	0.2446

**CIE 1976 v' data for tested units**

$T_s = T_{air} = 105^\circ\text{C}$ ,  $I_f = 150\text{mA}$ ;  $T_s \geq 103^\circ\text{C}$  and  $T_{air} \geq 100^\circ\text{C}$  in compliance with LM-80-15

	CCT (t=0)	0hrs	1000hrs	2000hrs	3000hrs	4000hrs	5000hrs	6000hrs	7000hrs	8000hrs	9000hrs	10000hrs
1	3006K	0.5249	0.5243	0.5239	0.5236	0.5234	0.5232	0.5228	0.5226	0.5224	0.5222	0.5218
2	3148K	0.5211	0.5205	0.5203	0.5199	0.5197	0.5194	0.5191	0.5188	0.5186	0.5183	0.5178
3	3132K	0.5190	0.5182	0.5179	0.5176	0.5173	0.5171	0.5168	0.5164	0.5163	0.5160	0.5155
4	3127K	0.5183	0.5176	0.5173	0.5169	0.5166	0.5164	0.5161	0.5158	0.5156	0.5153	0.5148
5	3147K	0.5198	0.5191	0.5189	0.5186	0.5183	0.5181	0.5178	0.5174	0.5172	0.5169	0.5165
6	3139K	0.5184	0.5178	0.5175	0.5171	0.5168	0.5167	0.5164	0.5161	0.5158	0.5156	0.5152
7	3161K	0.5183	0.5176	0.5174	0.5170	0.5167	0.5166	0.5163	0.5158	0.5157	0.5154	0.5150
8	3156K	0.5180	0.5173	0.5170	0.5167	0.5162	0.5160	0.5159	0.5155	0.5153	0.5150	0.5146
9	3145K	0.5183	0.5177	0.5175	0.5171	0.5168	0.5165	0.5163	0.5160	0.5158	0.5156	0.5152
10	3114K	0.5190	0.5182	0.5180	0.5176	0.5173	0.5171	0.5169	0.5165	0.5163	0.5161	0.5156
11	3106K	0.5179	0.5173	0.5169	0.5166	0.5163	0.5160	0.5157	0.5154	0.5152	0.5150	0.5146
12	3163K	0.5181	0.5175	0.5172	0.5169	0.5166	0.5163	0.5160	0.5157	0.5155	0.5153	0.5149
13	3161K	0.5177	0.5171	0.5168	0.5165	0.5161	0.5159	0.5156	0.5155	0.5151	0.5150	0.5145
14	3130K	0.5190	0.5184	0.5181	0.5178	0.5174	0.5171	0.5168	0.5167	0.5164	0.5163	0.5158
15	3127K	0.5187	0.5180	0.5177	0.5174	0.5171	0.5168	0.5165	0.5163	0.5161	0.5159	0.5155
16	3127K	0.5186	0.5180	0.5176	0.5172	0.5170	0.5167	0.5165	0.5162	0.5160	0.5158	0.5153
17	3109K	0.5190	0.5182	0.5179	0.5175	0.5172	0.5169	0.5166	0.5164	0.5162	0.5161	0.5154
18	2967K	0.5237	0.5230	0.5226	0.5223	0.5220	0.5218	0.5215	0.5212	0.5211	0.5209	0.5204
19	3158K	0.5174	0.5167	0.5164	0.5160	0.5157	0.5154	0.5152	0.5149	0.5147	0.5145	0.5140
20	3129K	0.5187	0.5179	0.5177	0.5174	0.5170	0.5167	0.5164	0.5163	0.5161	0.5159	0.5155
21	3107K	0.5192	0.5185	0.5182	0.5180	0.5175	0.5173	0.5170	0.5167	0.5165	0.5164	0.5159
22	3133K	0.5185	0.5178	0.5175	0.5172	0.5168	0.5166	0.5164	0.5160	0.5159	0.5157	0.5152
23	2988K	0.5271	0.5264	0.5261	0.5257	0.5254	0.5252	0.5249	0.5246	0.5244	0.5242	0.5238
24	3130K	0.5183	0.5176	0.5173	0.5169	0.5166	0.5163	0.5160	0.5157	0.5156	0.5154	0.5149
25	3127K	0.5197	0.5189	0.5186	0.5183	0.5180	0.5177	0.5175	0.5172	0.5170	0.5169	0.5164

**Delta u'v' data for tested units**

$T_s = T_{air} = 105^{\circ}\text{C}$ ,  $I_f = 150\text{mA}$ ;  $T_s \geq 103^{\circ}\text{C}$  and  $T_{air} \geq 100^{\circ}\text{C}$  in compliance with LM-80-15

	CCT (t=0)	0hrs	1000hrs	2000hrs	3000hrs	4000hrs	5000hrs	6000hrs	7000hrs	8000hrs	9000hrs	10000hrs
1	3006K	0.0000	0.0006	0.0010	0.0014	0.0017	0.0018	0.0021	0.0024	0.0027	0.0030	0.0033
2	3148K	0.0000	0.0007	0.0009	0.0013	0.0017	0.0019	0.0021	0.0024	0.0027	0.0032	0.0036
3	3132K	0.0000	0.0009	0.0012	0.0015	0.0019	0.0021	0.0023	0.0027	0.0029	0.0034	0.0038
4	3127K	0.0000	0.0008	0.0011	0.0015	0.0019	0.0021	0.0023	0.0026	0.0030	0.0034	0.0038
5	3147K	0.0000	0.0008	0.0010	0.0013	0.0017	0.0019	0.0021	0.0025	0.0029	0.0033	0.0037
6	3139K	0.0000	0.0007	0.0011	0.0014	0.0019	0.0019	0.0021	0.0024	0.0029	0.0032	0.0036
7	3161K	0.0000	0.0008	0.0010	0.0014	0.0018	0.0019	0.0021	0.0026	0.0029	0.0033	0.0036
8	3156K	0.0000	0.0009	0.0011	0.0014	0.0021	0.0022	0.0022	0.0026	0.0030	0.0034	0.0037
9	3145K	0.0000	0.0007	0.0009	0.0013	0.0017	0.0020	0.0021	0.0024	0.0027	0.0030	0.0034
10	3114K	0.0000	0.0009	0.0011	0.0015	0.0019	0.0021	0.0022	0.0026	0.0030	0.0033	0.0037
11	3106K	0.0000	0.0007	0.0011	0.0014	0.0018	0.0021	0.0023	0.0026	0.0029	0.0033	0.0036
12	3163K	0.0000	0.0007	0.0010	0.0013	0.0017	0.0020	0.0022	0.0025	0.0028	0.0031	0.0035
13	3161K	0.0000	0.0008	0.0010	0.0013	0.0019	0.0021	0.0022	0.0023	0.0029	0.0031	0.0035
14	3130K	0.0000	0.0007	0.0010	0.0013	0.0018	0.0021	0.0023	0.0024	0.0028	0.0030	0.0035
15	3127K	0.0000	0.0009	0.0011	0.0014	0.0019	0.0021	0.0023	0.0025	0.0028	0.0032	0.0035
16	3127K	0.0000	0.0008	0.0011	0.0015	0.0019	0.0021	0.0022	0.0026	0.0029	0.0032	0.0037
17	3109K	0.0000	0.0009	0.0012	0.0016	0.0021	0.0023	0.0025	0.0028	0.0030	0.0033	0.0040
18	2967K	0.0000	0.0009	0.0012	0.0015	0.0019	0.0021	0.0023	0.0026	0.0028	0.0032	0.0036
19	3158K	0.0000	0.0008	0.0011	0.0015	0.0020	0.0022	0.0023	0.0027	0.0029	0.0033	0.0038
20	3129K	0.0000	0.0010	0.0011	0.0014	0.0019	0.0022	0.0024	0.0026	0.0028	0.0031	0.0035
21	3107K	0.0000	0.0009	0.0011	0.0013	0.0020	0.0021	0.0023	0.0027	0.0030	0.0032	0.0036
22	3133K	0.0000	0.0008	0.0011	0.0014	0.0020	0.0021	0.0022	0.0027	0.0028	0.0031	0.0036
23	2988K	0.0000	0.0009	0.0011	0.0015	0.0020	0.0021	0.0023	0.0027	0.0030	0.0034	0.0037
24	3130K	0.0000	0.0009	0.0011	0.0015	0.0020	0.0022	0.0024	0.0028	0.0030	0.0033	0.0038
25	3127K	0.0000	0.0009	0.0012	0.0015	0.0020	0.0022	0.0023	0.0027	0.0029	0.0031	0.0036

**Forward Voltage [V] data for tested units**

$T_s = T_{air} = 105^{\circ}\text{C}$ ,  $I_f = 150\text{mA}$ ;  $T_s \geq 103^{\circ}\text{C}$  and  $T_{air} \geq 100^{\circ}\text{C}$  in compliance with LM-80-15

	CCT (t=0)	0hrs	1000hrs	2000hrs	3000hrs	4000hrs	5000hrs	6000hrs	7000hrs	8000hrs	9000hrs	10000hrs
1	3006K	6.011	6.018	6.012	6.044	6.023	6.052	6.026	6.053	6.009	6.010	6.012
2	3148K	5.989	5.956	6.124	6.003	5.966	5.985	6.211	5.962	5.955	5.952	5.955
3	3132K	6.042	6.029	6.037	6.046	6.045	6.036	6.039	6.037	6.072	6.024	6.029
4	3127K	5.982	5.981	5.973	5.982	6.064	5.982	5.985	5.981	5.968	5.970	5.971
5	3147K	5.991	5.965	5.978	6.264	5.972	5.968	5.958	5.952	5.944	5.943	5.945
6	3139K	6.049	6.010	5.999	6.023	6.018	6.206	6.011	5.999	5.993	5.992	5.998
7	3161K	6.013	5.970	5.978	5.985	6.000	6.060	5.987	5.974	5.973	5.965	5.977
8	3156K	5.929	5.939	5.939	6.135	5.972	6.061	5.962	5.957	5.937	5.925	5.927
9	3145K	5.969	5.964	5.972	6.075	5.989	5.988	5.977	5.974	5.966	5.960	5.969
10	3114K	6.036	6.070	6.033	6.198	6.050	6.160	6.039	6.035	6.284	6.028	6.030
11	3106K	6.014	6.022	6.030	6.264	6.026	6.068	6.087	6.044	6.016	6.015	6.030
12	3163K	6.023	5.947	5.991	5.994	5.956	6.118	5.992	5.951	5.940	5.941	5.950
13	3161K	6.001	5.996	5.941	5.952	5.947	6.071	5.944	5.974	5.931	5.936	5.941
14	3130K	6.031	6.002	6.009	6.011	6.008	6.061	6.004	6.003	5.992	5.996	6.000
15	3127K	6.011	5.929	5.923	5.936	5.932	6.103	5.926	5.922	5.914	5.914	5.922
16	3127K	6.036	5.990	6.058	6.014	5.998	6.119	6.007	5.991	5.984	5.984	5.993
17	3109K	5.950	5.976	6.064	5.948	6.015	5.981	5.975	5.936	5.935	5.937	5.940
18	2967K	6.033	6.018	6.140	6.011	6.027	6.179	6.017	6.008	6.006	6.005	6.012
19	3158K	6.016	6.102	6.014	6.082	6.077	6.217	6.023	6.022	6.096	6.010	6.015
20	3129K	5.956	6.022	5.937	5.978	5.948	6.014	5.952	5.943	6.179	5.940	5.961
21	3107K	6.026	6.322	6.036	6.034	6.016	6.096	6.040	6.027	6.023	6.022	6.046
22	3133K	5.946	5.980	5.958	6.267	6.001	6.099	5.958	5.951	5.951	5.941	5.949
23	2988K	6.003	5.955	5.966	5.962	5.989	6.081	5.962	5.953	5.996	5.949	5.957
24	3130K	5.980	5.965	6.015	5.934	5.943	5.932	5.973	6.170	5.917	5.920	5.943
25	3127K	6.013	6.305	6.019	6.020	6.164	6.024	6.023	6.016	6.016	6.012	6.022

**Luminous Flux [lm] data for tested units**

**$T_s = T_{air} = 115^{\circ}C, I_f = 180mA; T_s \geq 113^{\circ}C$  and  $T_{air} \geq 110^{\circ}C$  in compliance with LM-80-15**

	CCT (t=0)	0hrs	1000hrs	2000hrs	3000hrs	4000hrs	5000hrs	6000hrs	7000hrs	8000hrs	9000hrs	10000hrs
1	3134K	182.600	181.400	180.700	180.100	179.600	179.000	178.400	177.900	177.300	176.700	176.100
2	3121K	179.700	178.500	177.900	177.300	176.600	175.700	175.200	174.600	174.200	173.400	172.800
3	3143K	181.500	180.700	179.900	179.400	178.700	178.200	177.600	177.000	176.400	175.700	174.900
4	3107K	179.600	178.600	178.000	177.200	176.500	175.900	175.300	174.500	174.200	173.900	173.300
5	3116K	182.600	181.600	181.000	180.800	180.200	179.700	179.200	178.600	178.100	177.600	176.800
6	3169K	181.500	180.600	180.200	179.500	178.700	178.100	177.400	177.000	176.800	176.200	175.500
7	3142K	180.700	179.600	178.800	178.300	177.600	177.000	176.700	176.000	175.600	175.000	174.600
8	3152K	180.500	180.200	179.600	179.100	178.100	177.500	176.800	176.200	175.800	175.100	174.500
9	3149K	175.900	175.700	175.400	175.000	174.100	173.500	173.000	172.300	171.700	171.200	170.300
10	3164K	180.600	180.000	179.700	179.100	178.600	178.000	177.600	177.000	176.100	175.400	174.700
11	3147K	176.900	175.900	175.300	174.800	174.400	173.700	173.300	172.900	172.400	171.600	171.100
12	3171K	184.300	183.400	182.700	182.200	181.500	180.900	180.400	179.800	179.400	178.800	178.400
13	3155K	181.500	180.400	179.900	179.100	178.500	177.900	177.400	177.200	176.700	176.100	175.400
14	3139K	178.500	177.200	176.500	175.900	175.400	174.800	174.000	173.700	173.200	172.600	172.400
15	3182K	177.800	177.100	176.600	175.900	175.100	174.700	174.200	173.300	172.900	172.500	171.700
16	3134K	177.400	176.400	176.000	175.500	174.900	174.200	173.800	173.100	172.400	171.900	171.300
17	3163K	181.800	180.900	180.200	179.800	179.300	179.100	178.500	177.800	176.900	176.400	175.800
18	3113K	177.500	176.400	176.000	175.600	174.800	174.000	173.700	173.100	172.600	171.800	171.600
19	3149K	179.300	178.400	177.900	177.300	176.800	176.100	175.200	174.800	174.300	173.700	173.200
20	3122K	180.500	180.000	179.400	178.800	178.200	177.600	177.100	176.600	175.900	175.500	174.900
21	3149K	178.800	178.100	177.500	176.800	176.100	175.600	175.200	174.500	173.900	173.300	172.600
22	3114K	178.600	178.100	177.400	177.100	176.400	175.800	175.100	174.800	174.100	173.600	173.000
23	3147K	177.600	176.400	175.900	175.400	174.600	174.200	173.600	173.000	172.600	172.000	171.400
24	3150K	178.100	176.800	176.200	175.700	174.800	174.200	173.300	172.800	172.300	172.000	171.300
25	3144K	181.400	179.900	179.100	178.600	177.600	177.000	176.300	175.600	175.200	174.700	174.300

**Normalized Luminous Flux data for tested units**

**$T_s = T_{air} = 115^{\circ}C, I_f = 180mA; T_s \geq 113^{\circ}C$  and  $T_{air} \geq 110^{\circ}C$  in compliance with LM-80-15**

	CCT (t=0)	0hrs	1000hrs	2000hrs	3000hrs	4000hrs	5000hrs	6000hrs	7000hrs	8000hrs	9000hrs	10000hrs
1	3134K	1.0000	0.9934	0.9896	0.9863	0.9836	0.9803	0.9770	0.9743	0.9710	0.9677	0.9644
2	3121K	1.0000	0.9933	0.9900	0.9866	0.9827	0.9777	0.9750	0.9716	0.9694	0.9649	0.9616
3	3143K	1.0000	0.9956	0.9912	0.9884	0.9846	0.9818	0.9785	0.9752	0.9719	0.9680	0.9636
4	3107K	1.0000	0.9944	0.9911	0.9866	0.9827	0.9794	0.9761	0.9716	0.9699	0.9683	0.9649
5	3116K	1.0000	0.9945	0.9912	0.9901	0.9869	0.9841	0.9814	0.9781	0.9754	0.9726	0.9682
6	3169K	1.0000	0.9950	0.9928	0.9890	0.9846	0.9813	0.9774	0.9752	0.9741	0.9708	0.9669
7	3142K	1.0000	0.9939	0.9895	0.9867	0.9828	0.9795	0.9779	0.9740	0.9718	0.9685	0.9662
8	3152K	1.0000	0.9983	0.9950	0.9922	0.9867	0.9834	0.9795	0.9762	0.9740	0.9701	0.9668
9	3149K	1.0000	0.9989	0.9972	0.9949	0.9898	0.9864	0.9835	0.9795	0.9761	0.9733	0.9682
10	3164K	1.0000	0.9967	0.9950	0.9917	0.9889	0.9856	0.9834	0.9801	0.9751	0.9712	0.9673
11	3147K	1.0000	0.9943	0.9910	0.9881	0.9859	0.9819	0.9796	0.9774	0.9746	0.9700	0.9672
12	3171K	1.0000	0.9951	0.9913	0.9886	0.9848	0.9816	0.9788	0.9756	0.9734	0.9702	0.9680
13	3155K	1.0000	0.9939	0.9912	0.9868	0.9835	0.9802	0.9774	0.9763	0.9736	0.9702	0.9664
14	3139K	1.0000	0.9927	0.9888	0.9854	0.9826	0.9793	0.9748	0.9731	0.9703	0.9669	0.9658
15	3182K	1.0000	0.9961	0.9933	0.9893	0.9848	0.9826	0.9798	0.9747	0.9724	0.9702	0.9657
16	3134K	1.0000	0.9944	0.9921	0.9893	0.9859	0.9820	0.9797	0.9758	0.9718	0.9690	0.9656
17	3163K	1.0000	0.9950	0.9912	0.9890	0.9862	0.9851	0.9818	0.9780	0.9730	0.9703	0.9670
18	3113K	1.0000	0.9938	0.9915	0.9893	0.9848	0.9803	0.9786	0.9752	0.9724	0.9679	0.9668
19	3149K	1.0000	0.9950	0.9922	0.9888	0.9861	0.9822	0.9771	0.9749	0.9721	0.9688	0.9660
20	3122K	1.0000	0.9972	0.9939	0.9906	0.9873	0.9839	0.9812	0.9784	0.9745	0.9723	0.9690
21	3149K	1.0000	0.9961	0.9927	0.9888	0.9849	0.9821	0.9799	0.9760	0.9726	0.9692	0.9653
22	3114K	1.0000	0.9972	0.9933	0.9916	0.9877	0.9843	0.9804	0.9787	0.9748	0.9720	0.9686
23	3147K	1.0000	0.9932	0.9904	0.9876	0.9831	0.9809	0.9775	0.9741	0.9718	0.9685	0.9651
24	3150K	1.0000	0.9927	0.9893	0.9865	0.9815	0.9781	0.9730	0.9702	0.9674	0.9657	0.9618
25	3144K	1.0000	0.9917	0.9873	0.9846	0.9791	0.9757	0.9719	0.9680	0.9658	0.9631	0.9609

**CIE 1976 u' data for tested units**

$T_s = T_{air} = 115^\circ\text{C}$ ,  $I_f = 180\text{mA}$ ;  $T_s \geq 113^\circ\text{C}$  and  $T_{air} \geq 110^\circ\text{C}$  in compliance with LM-80-15

	CCT (t=0)	0hrs	1000hrs	2000hrs	3000hrs	4000hrs	5000hrs	6000hrs	7000hrs	8000hrs	9000hrs	10000hrs
1	3134K	0.2459	0.2455	0.2454	0.2454	0.2450	0.2448	0.2451	0.2450	0.2445	0.2444	0.2444
2	3121K	0.2467	0.2463	0.2462	0.2461	0.2458	0.2456	0.2459	0.2458	0.2454	0.2453	0.2451
3	3143K	0.2456	0.2453	0.2454	0.2452	0.2449	0.2449	0.2449	0.2449	0.2446	0.2444	0.2442
4	3107K	0.2470	0.2468	0.2469	0.2466	0.2464	0.2464	0.2465	0.2464	0.2461	0.2459	0.2458
5	3116K	0.2468	0.2463	0.2464	0.2463	0.2459	0.2459	0.2460	0.2459	0.2457	0.2455	0.2455
6	3169K	0.2447	0.2445	0.2445	0.2442	0.2439	0.2440	0.2440	0.2439	0.2436	0.2434	0.2433
7	3142K	0.2460	0.2457	0.2457	0.2455	0.2452	0.2452	0.2454	0.2452	0.2449	0.2446	0.2447
8	3152K	0.2453	0.2451	0.2451	0.2449	0.2446	0.2446	0.2446	0.2445	0.2443	0.2440	0.2441
9	3149K	0.2455	0.2452	0.2452	0.2450	0.2447	0.2447	0.2447	0.2447	0.2445	0.2443	0.2445
10	3164K	0.2452	0.2447	0.2448	0.2445	0.2442	0.2443	0.2444	0.2442	0.2440	0.2438	0.2438
11	3147K	0.2457	0.2453	0.2453	0.2450	0.2448	0.2448	0.2449	0.2448	0.2445	0.2442	0.2443
12	3171K	0.2445	0.2441	0.2441	0.2439	0.2436	0.2436	0.2437	0.2436	0.2433	0.2431	0.2432
13	3155K	0.2453	0.2449	0.2449	0.2446	0.2444	0.2444	0.2445	0.2444	0.2441	0.2439	0.2439
14	3139K	0.2458	0.2454	0.2455	0.2452	0.2449	0.2450	0.2450	0.2450	0.2447	0.2445	0.2447
15	3182K	0.2447	0.2444	0.2444	0.2440	0.2438	0.2439	0.2439	0.2439	0.2436	0.2434	0.2434
16	3134K	0.2462	0.2459	0.2460	0.2457	0.2455	0.2455	0.2456	0.2455	0.2453	0.2450	0.2450
17	3163K	0.2445	0.2441	0.2441	0.2439	0.2436	0.2436	0.2437	0.2436	0.2434	0.2432	0.2431
18	3113K	0.2471	0.2468	0.2468	0.2466	0.2463	0.2463	0.2463	0.2462	0.2461	0.2458	0.2459
19	3149K	0.2453	0.2448	0.2449	0.2445	0.2443	0.2444	0.2444	0.2444	0.2441	0.2437	0.2437
20	3122K	0.2465	0.2463	0.2463	0.2460	0.2457	0.2457	0.2458	0.2457	0.2455	0.2452	0.2452
21	3149K	0.2455	0.2451	0.2451	0.2449	0.2446	0.2446	0.2447	0.2447	0.2444	0.2440	0.2441
22	3114K	0.2471	0.2469	0.2469	0.2468	0.2464	0.2465	0.2465	0.2464	0.2462	0.2460	0.2459
23	3147K	0.2457	0.2454	0.2455	0.2453	0.2451	0.2452	0.2452	0.2451	0.2448	0.2446	0.2446
24	3150K	0.2454	0.2451	0.2451	0.2449	0.2446	0.2447	0.2448	0.2447	0.2445	0.2442	0.2441
25	3144K	0.2458	0.2456	0.2457	0.2454	0.2451	0.2452	0.2452	0.2451	0.2450	0.2446	0.2447

**CIE 1976 v' data for tested units**

$T_s = T_{air} = 115^\circ\text{C}$ ,  $I_f = 180\text{mA}$ ;  $T_s \geq 113^\circ\text{C}$  and  $T_{air} \geq 110^\circ\text{C}$  in compliance with LM-80-15

	CCT (t=0)	0hrs	1000hrs	2000hrs	3000hrs	4000hrs	5000hrs	6000hrs	7000hrs	8000hrs	9000hrs	10000hrs
1	3134K	0.5191	0.5183	0.5180	0.5177	0.5174	0.5171	0.5167	0.5164	0.5164	0.5161	0.5156
2	3121K	0.5180	0.5171	0.5168	0.5164	0.5162	0.5158	0.5154	0.5152	0.5151	0.5150	0.5145
3	3143K	0.5190	0.5183	0.5180	0.5176	0.5174	0.5171	0.5167	0.5164	0.5163	0.5162	0.5158
4	3107K	0.5189	0.5183	0.5180	0.5176	0.5173	0.5171	0.5166	0.5163	0.5162	0.5162	0.5157
5	3116K	0.5183	0.5176	0.5173	0.5169	0.5166	0.5164	0.5159	0.5157	0.5156	0.5155	0.5151
6	3169K	0.5187	0.5182	0.5178	0.5174	0.5170	0.5168	0.5164	0.5161	0.5160	0.5159	0.5155
7	3142K	0.5177	0.5171	0.5167	0.5164	0.5161	0.5159	0.5154	0.5151	0.5150	0.5149	0.5146
8	3152K	0.5189	0.5183	0.5179	0.5176	0.5173	0.5170	0.5165	0.5162	0.5162	0.5160	0.5156
9	3149K	0.5185	0.5179	0.5176	0.5172	0.5169	0.5166	0.5162	0.5159	0.5158	0.5157	0.5155
10	3164K	0.5176	0.5168	0.5165	0.5161	0.5157	0.5155	0.5151	0.5148	0.5147	0.5146	0.5145
11	3147K	0.5181	0.5173	0.5169	0.5165	0.5162	0.5159	0.5155	0.5153	0.5152	0.5150	0.5148
12	3171K	0.5192	0.5184	0.5180	0.5177	0.5174	0.5171	0.5167	0.5164	0.5163	0.5162	0.5159
13	3155K	0.5184	0.5177	0.5174	0.5169	0.5167	0.5164	0.5160	0.5157	0.5157	0.5156	0.5153
14	3139K	0.5188	0.5181	0.5178	0.5174	0.5171	0.5169	0.5164	0.5162	0.5161	0.5160	0.5160
15	3182K	0.5171	0.5164	0.5161	0.5157	0.5154	0.5152	0.5147	0.5145	0.5144	0.5143	0.5139
16	3134K	0.5180	0.5174	0.5172	0.5168	0.5165	0.5163	0.5158	0.5155	0.5154	0.5153	0.5150
17	3163K	0.5202	0.5191	0.5188	0.5184	0.5181	0.5180	0.5174	0.5171	0.5171	0.5170	0.5166
18	3113K	0.5177	0.5170	0.5167	0.5163	0.5161	0.5158	0.5153	0.5150	0.5150	0.5149	0.5145
19	3149K	0.5193	0.5186	0.5184	0.5179	0.5177	0.5175	0.5170	0.5168	0.5166	0.5165	0.5161
20	3122K	0.5186	0.5180	0.5177	0.5172	0.5169	0.5167	0.5162	0.5159	0.5158	0.5157	0.5153
21	3149K	0.5185	0.5177	0.5175	0.5170	0.5167	0.5165	0.5160	0.5158	0.5157	0.5155	0.5152
22	3114K	0.5176	0.5170	0.5167	0.5163	0.5160	0.5158	0.5154	0.5151	0.5150	0.5150	0.5145
23	3147K	0.5181	0.5175	0.5173	0.5169	0.5167	0.5165	0.5159	0.5156	0.5156	0.5155	0.5151
24	3150K	0.5187	0.5180	0.5176	0.5172	0.5170	0.5168	0.5164	0.5160	0.5160	0.5159	0.5154
25	3144K	0.5182	0.5176	0.5172	0.5169	0.5166	0.5164	0.5159	0.5156	0.5155	0.5154	0.5150

**Delta u'v' data for tested units**

$T_s = T_{air} = 115^{\circ}\text{C}$ ,  $I_f = 180\text{mA}$ ;  $T_s \geq 113^{\circ}\text{C}$  and  $T_{air} \geq 110^{\circ}\text{C}$  in compliance with LM-80-15

	CCT (t=0)	0hrs	1000hrs	2000hrs	3000hrs	4000hrs	5000hrs	6000hrs	7000hrs	8000hrs	9000hrs	10000hrs
1	3134K	0.0000	0.0009	0.0012	0.0015	0.0019	0.0023	0.0025	0.0028	0.0030	0.0034	0.0038
2	3121K	0.0000	0.0010	0.0013	0.0017	0.0020	0.0025	0.0027	0.0029	0.0032	0.0033	0.0038
3	3143K	0.0000	0.0008	0.0010	0.0015	0.0017	0.0020	0.0024	0.0027	0.0029	0.0030	0.0035
4	3107K	0.0000	0.0006	0.0009	0.0014	0.0017	0.0019	0.0024	0.0027	0.0028	0.0029	0.0034
5	3116K	0.0000	0.0009	0.0011	0.0015	0.0019	0.0021	0.0025	0.0028	0.0029	0.0031	0.0035
6	3169K	0.0000	0.0005	0.0009	0.0014	0.0019	0.0020	0.0024	0.0027	0.0029	0.0031	0.0035
7	3142K	0.0000	0.0007	0.0010	0.0014	0.0018	0.0020	0.0024	0.0027	0.0029	0.0031	0.0034
8	3152K	0.0000	0.0006	0.0010	0.0014	0.0017	0.0020	0.0025	0.0028	0.0029	0.0032	0.0035
9	3149K	0.0000	0.0007	0.0009	0.0014	0.0018	0.0021	0.0024	0.0027	0.0029	0.0030	0.0032
10	3164K	0.0000	0.0009	0.0012	0.0017	0.0021	0.0023	0.0026	0.0030	0.0031	0.0033	0.0034
11	3147K	0.0000	0.0009	0.0013	0.0017	0.0021	0.0024	0.0027	0.0029	0.0031	0.0034	0.0036
12	3171K	0.0000	0.0009	0.0013	0.0016	0.0020	0.0023	0.0026	0.0029	0.0031	0.0033	0.0035
13	3155K	0.0000	0.0008	0.0011	0.0017	0.0019	0.0022	0.0025	0.0028	0.0030	0.0031	0.0034
14	3139K	0.0000	0.0008	0.0010	0.0015	0.0019	0.0021	0.0025	0.0027	0.0029	0.0031	0.0030
15	3182K	0.0000	0.0008	0.0010	0.0016	0.0019	0.0021	0.0025	0.0027	0.0029	0.0031	0.0035
16	3134K	0.0000	0.0007	0.0008	0.0013	0.0017	0.0018	0.0023	0.0026	0.0028	0.0030	0.0032
17	3163K	0.0000	0.0012	0.0015	0.0019	0.0023	0.0024	0.0029	0.0032	0.0033	0.0035	0.0039
18	3113K	0.0000	0.0008	0.0010	0.0015	0.0018	0.0021	0.0025	0.0028	0.0029	0.0031	0.0034
19	3149K	0.0000	0.0009	0.0010	0.0016	0.0019	0.0020	0.0025	0.0027	0.0030	0.0032	0.0036
20	3122K	0.0000	0.0006	0.0009	0.0015	0.0019	0.0021	0.0025	0.0028	0.0030	0.0032	0.0035
21	3149K	0.0000	0.0009	0.0011	0.0016	0.0020	0.0022	0.0026	0.0028	0.0030	0.0034	0.0036
22	3114K	0.0000	0.0006	0.0009	0.0013	0.0017	0.0019	0.0023	0.0026	0.0028	0.0028	0.0033
23	3147K	0.0000	0.0007	0.0008	0.0013	0.0015	0.0017	0.0023	0.0026	0.0027	0.0028	0.0032
24	3150K	0.0000	0.0008	0.0011	0.0016	0.0019	0.0020	0.0024	0.0028	0.0028	0.0030	0.0035
25	3144K	0.0000	0.0006	0.0010	0.0014	0.0017	0.0019	0.0024	0.0027	0.0028	0.0030	0.0034

**Forward Voltage [V] data for tested units**

$T_s = T_{air} = 115^{\circ}\text{C}$ ,  $I_f = 180\text{mA}$ ;  $T_s \geq 113^{\circ}\text{C}$  and  $T_{air} \geq 110^{\circ}\text{C}$  in compliance with LM-80-15

	CCT (t=0)	0hrs	1000hrs	2000hrs	3000hrs	4000hrs	5000hrs	6000hrs	7000hrs	8000hrs	9000hrs	10000hrs
1	3134K	6.048	6.049	6.045	6.067	6.242	6.051	6.050	6.050	6.052	6.046	6.115
2	3121K	6.032	6.150	6.128	6.035	6.034	6.088	6.033	6.043	6.036	6.029	6.031
3	3143K	6.160	6.224	6.228	6.261	6.176	6.185	6.165	6.163	6.153	6.161	6.159
4	3107K	6.148	6.186	6.326	6.170	6.170	6.185	6.155	6.151	6.144	6.145	6.151
5	3116K	6.154	6.136	6.177	6.160	6.160	6.177	6.156	6.152	6.146	6.149	6.150
6	3169K	6.188	6.185	6.165	6.176	6.176	6.155	6.174	6.166	6.164	6.163	6.168
7	3142K	6.094	6.284	6.068	6.075	6.071	6.133	6.091	6.157	6.067	6.063	6.064
8	3152K	6.180	6.211	6.220	6.179	6.188	6.258	6.178	6.175	6.174	6.165	6.174
9	3149K	6.116	6.132	6.107	6.420	6.388	6.188	6.120	6.131	6.118	6.112	6.136
10	3164K	6.154	6.173	6.154	6.167	6.183	6.191	6.161	6.149	6.156	6.149	6.190
11	3147K	6.161	6.171	6.167	6.164	6.173	6.281	6.217	6.167	6.149	6.152	6.162
12	3171K	6.211	6.167	6.148	6.404	6.173	6.167	6.147	6.155	6.145	6.159	6.148
13	3155K	6.209	6.160	6.516	6.176	6.292	6.186	6.233	6.160	6.179	6.151	6.154
14	3139K	6.170	6.141	6.171	6.145	6.159	6.156	6.130	6.134	6.127	6.122	6.137
15	3182K	6.186	6.187	6.146	6.153	6.149	6.147	6.150	6.141	6.138	6.135	6.162
16	3134K	6.159	6.201	6.139	6.179	6.152	6.192	6.151	6.143	6.133	6.134	6.143
17	3163K	6.219	6.192	6.136	6.302	6.167	6.160	6.139	6.130	6.126	6.124	6.130
18	3113K	6.082	6.065	6.056	6.181	6.058	6.100	6.056	6.103	6.056	6.049	6.055
19	3149K	6.059	6.101	6.065	6.102	6.102	6.100	6.055	6.071	6.065	6.059	6.112
20	3122K	6.128	6.265	6.129	6.160	6.135	6.138	6.136	6.139	6.134	6.117	6.131
21	3149K	6.064	6.091	6.077	6.070	6.102	6.074	6.068	6.068	6.065	6.065	6.080
22	3114K	6.121	6.056	6.057	6.058	6.060	6.276	6.060	6.056	6.050	6.051	6.051
23	3147K	6.148	6.157	6.138	6.151	6.170	6.254	6.142	6.142	6.149	6.134	6.138
24	3150K	6.210	6.160	6.141	6.157	6.174	6.218	6.149	6.213	6.136	6.135	6.156
25	3144K	6.143	6.099	6.101	6.107	6.103	6.106	6.103	6.112	6.100	6.100	6.103

## Disclaimer

Neither Lumileds Holding B.V. nor its affiliates shall be liable for any kind of loss of data or any other damages, direct, indirect or consequential, resulting from the use of the provided information and data. Although Lumileds Holding B.V. and/or its affiliates have attempted to provide the most accurate information and data, the materials and services information and data are provided "as is," and neither Lumileds Holding B.V. nor its affiliates warrants or guarantees the contents and correctness of the provided information and data. Lumileds Holding B.V. and its affiliates reserve the right to make changes without notice. You as user agree to this disclaimer and user agreement with the download or use of the provided materials, information and data.

## Company Information

Lumileds is a leading provider of power LEDs for everyday lighting applications. The company's records for light output, efficacy and thermal management are direct results of the ongoing commitment to advancing solid-state lighting technology and enabling lighting solutions that are more environmentally friendly, help reduce CO2 emissions and reduce the need for power plant expansion. Lumileds LUXEON LEDs are enabling never before possible applications in outdoor lighting, shop lighting, home lighting, digital imaging, display and automotive lighting.

Lumileds is a fully integrated supplier, producing core LED material in all three base colors, (red, green, blue) and white. Lumileds has R & D centers in San Jose, California and in the Netherlands, and production capabilities in San Jose, Singapore and Penang, Malaysia. Founded in 1999, Lumileds is the high flux LED technology leader and is dedicated to bridging the gap between solid-state technology and the lighting world. More information about the company's LUXEON LED products and solid-state lighting technologies can be found at [www.lumileds.com](http://www.lumileds.com).

This report issued to HXIM

Appendix: Additional Projected Extrapolations per IESNA TM-21-11

Projected  $L_{75}$  extrapolations per IESNA TM-21-11

	If = 65mA	If = 100mA	If = 120mA	If = 150mA	If = 180mA
Ts = 115°C	-	-	114,987	-	89,057
Ts = 105°C	144,166	-	114,424	103,513	-
Ts = 85°C	-	123,862	-	-	-
Ts = 55°C	163,913	-	-	-	-

Projected  $L_{80}$  extrapolations per IESNA TM-21-11

	If = 65mA	If = 100mA	If = 120mA	If = 150mA	If = 180mA
Ts = 115°C	-	-	88,980	-	68,899
Ts = 105°C	112,426	-	88,951	80,101	-
Ts = 85°C	-	96,395	-	-	-
Ts = 55°C	128,166	-	-	-	-

Projected  $L_{85}$  extrapolations per IESNA TM-21-11

	If = 65mA	If = 100mA	If = 120mA	If = 150mA	If = 180mA
Ts = 115°C	-	-	64,550	-	49,963
Ts = 105°C	82,610	-	65,022	58,108	-
Ts = 85°C	-	70,593	-	-	-
Ts = 55°C	94,588	-	-	-	-

Projected  $L_{90}$  extrapolations per IESNA TM-21-11

	If = 65mA	If = 100mA	If = 120mA	If = 150mA	If = 180mA
Ts = 115°C	-	-	41,517	-	32,110
Ts = 105°C	54,500	-	42,462	37,373	-
Ts = 85°C	-	46,267	-	-	-
Ts = 55°C	62,929	-	-	-	-

This report issued to HYM